

# LANVRT10

## Instructions

Lankota Vertical Unload Auger Removal Tool for JD® 00 to S series combines





# LANKOTA®

**270 West Park Avenue  
Huron, SD 57350  
866-526-5682**

# Numerical Parts List

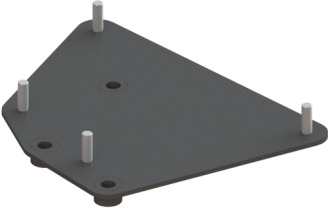
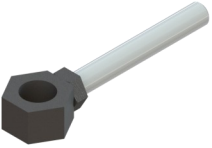
Part Numbers	Description	Quantity
LANVRT101	Pivot Weldment	1
LANVRT102	Pivot Tube	1
LANVRT103	Cherry Picker Tube	1
LANVRT104	Adjustment Screw	1
LANVRT105	Pivot Weldment Adapter	1
LANVRT106	Adjustment Nut	1
LANVRT107	Bolt Plate	1
LANVRT108	Plastic Wedge	2
LANMINI360QR	Quick Release Clamp: 48-51mm ID	1
<b>LANVRT10BH</b>	<b>Bag of Hardware Includes:</b>	<b>1</b>
LANFWS55	SAE Flat Washer - 1/2"	6
LANFWS58	SAE Flat Washer - 3/4"	2
RED1F30	Top Lock Nut - 1/2"-13, Gr. 5	3
LANB514	Hex Head Cap Screw - 1/2"-13 x 3.50", Gr. 5	1
LANSS604	1/2" x 3" Solid Hitch Pin	2
RENAF3	Hex Nut - 3/8"-16, Gr. 5	4
LANF2IPD	Flat Washer - M10	3
LANFP560	Hex Head Cap Screw - M10-1.5 x 60mm, Gr. 8.8	3
LANFOI7W	1/4" x 1.50" Slotted Spring Pin	2

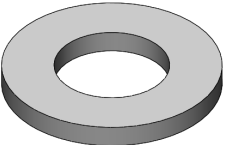
# Pictorial Parts List

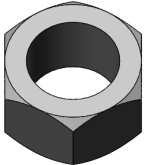
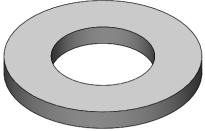
				
LANVRT101 (1)	LANVRT102 (1)	LANVRT103 (1)	LANVRT104 (1)	LANVRT107 (1)
				
LANVRT106 (1)	LANVRT105 (1)	LANMINI360QR (1)	LANSS604 (2)	LANVRT108 (2)
				
LANFWS58 (2)	LANFWS55 (6)	RED1F30 (3)	LANF017W (2)	LANB514 (1)
				
REDNAF3 (4)	LANF2IPD (3)	LANFP560 (3)		

# Disclaimer

**NOTE:**

This product is only to be used to aid in the removal of vertical unload augers on John Deere \*\*00 to S series combines. The combine owners manual should always be followed when performing any service or maintenance to the combine. Any information in these instructions is purely for the use of the Lankota product.



# Assembly

**NOTE: This product must be assembled prior to use. This exploded view can be used as a reference.**

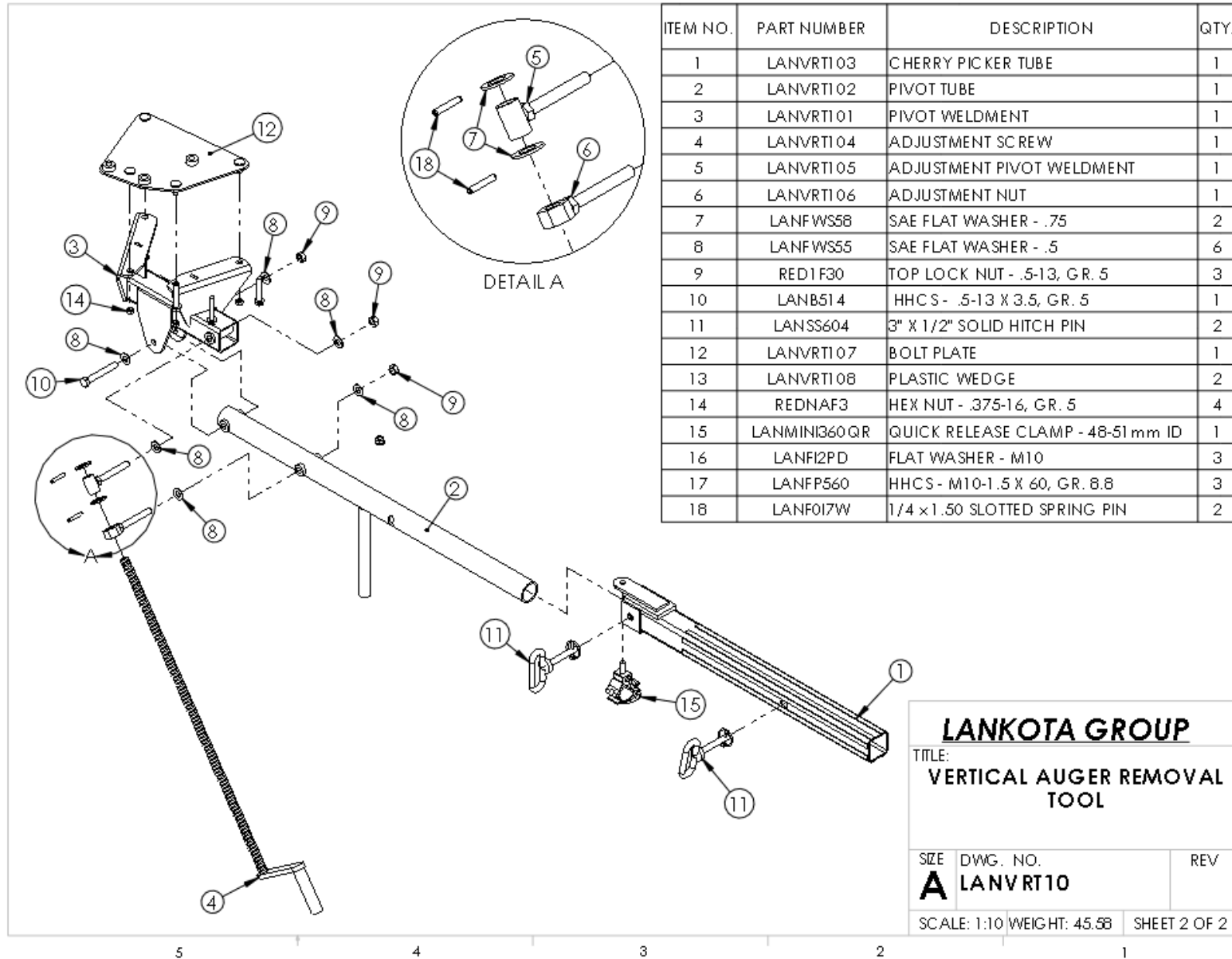

# Assembly

Below is the assembled product

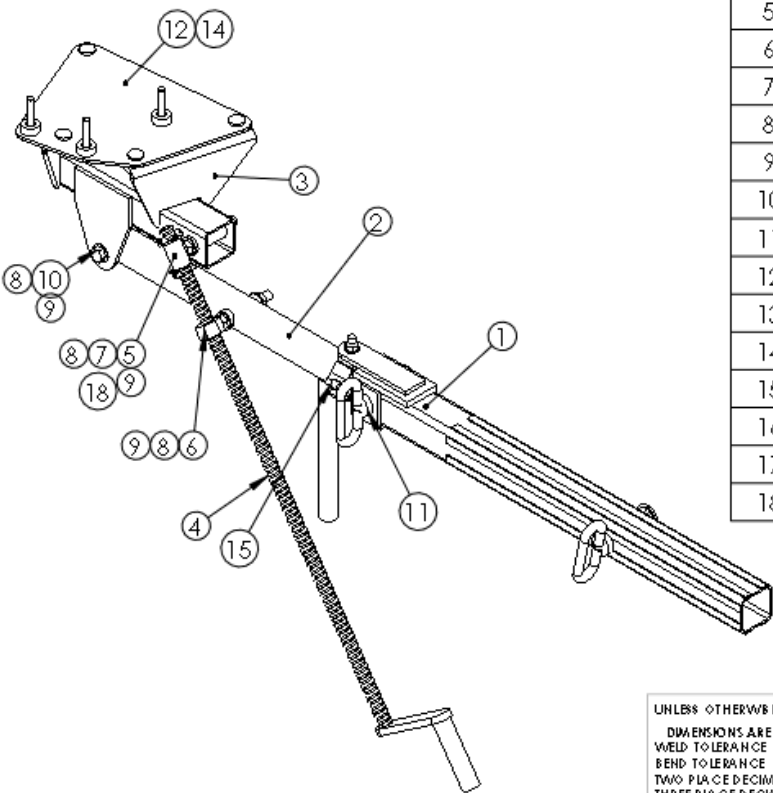

ITEM NO.	PART NUMBER	DESCRIPTION	QTY.
1	LANVRT103	CHERRY PICKER TUBE	1
2	LANVRT102	PIVOT TUBE	1
3	LANVRT101	PIVOT WELDMENT	1
4	LANVRT104	ADJUSTMENT SCREW	1
5	LANVRT105	ADJUSTMENT PIVOT WELDMENT	1
6	LANVRT106	ADJUSTMENT NUT	1
7	LANFWS58	SAE FLAT WASHER - .75	2
8	LANFWS55	SAE FLAT WASHER - .5	6
9	RED1F30	TOP LOCK NUT - .5-13, GR. 5	3
10	LANB514	HHCS - .5-13 X 3.5, GR. 5	1
11	LANSS604	3" X 1/2" SOLID HITCH PIN	2
12	LANVRT107	BOLT PLATE	1
13	LANVRT108	PLASTIC WEDGE	2
14	REDNAF3	HEX NUT - .375-16, GR. 5	4
15	LANMINI360QR	QUICK RELEASE CLAMP - 48-51mm ID	1
16	LANFI2PD	FLAT WASHER - M10	3
17	LANFP560	HHCS - M10-1.5 X 60, GR. 8.8	3
18	LANF017W	1/4 x 1.50 SLOTTED SPRING PIN	2

UNLESS OTHERWISE SPECIFIED:  
 DIMENSIONS ARE IN INCHES  
 WELD TOLERANCE ± 0.06  
 BEND TOLERANCE ± 0.06  
 TWO PLACE DECIMAL ± 0.02  
 THREE PLACE DECIMAL ± 0.002

MATERIAL: \_\_\_\_\_  
 FINISH: \_\_\_\_\_  
 DO NOT SCALE DRAWING

DRAWN BY: CHRIS OFFER  
 CREATED: 11/28/2016 4:41:21 PM  
 LAST SAVED: 1/19/2018 1:25:26 PM  
 MFG APPR. \_\_\_\_\_  
 Q.A. \_\_\_\_\_  
 COMMENTS: \_\_\_\_\_

PROPRIETARY AND CONFIDENTIAL  
 THE INFORMATION CONTAINED IN THIS DRAWING IS THE SOLE PROPERTY OF LANKOTA GROUP INC. ANY REPRODUCTION IN PART OR AS A WHOLE WITHOUT THE WRITTEN PERMISSION OF LANKOTA GROUP IS PROHIBITED.

**LANKOTA GROUP**  
 TITLE:  
**VERTICAL AUGER REMOVAL TOOL**

SIZE	DWG. NO.	REV
<b>A</b>	<b>LANVRT10</b>	

SCALE: 1:8    WEIGHT: 45.58    SHEET 1 OF 2

# Assembly

Attach the tool to a cherry picker using the provided pin (LANSS604) as shown below. Loosen the clamp (LANMINI360QR) at this time. This will allow for easier attachment to the auger gearbox.



# In Use

**Refer to Figures 1.1 & 1.2**

1. Remove the chain guard.
2. Remove the lower gearbox cover plates and set aside. The bolts from this step will be used later on.

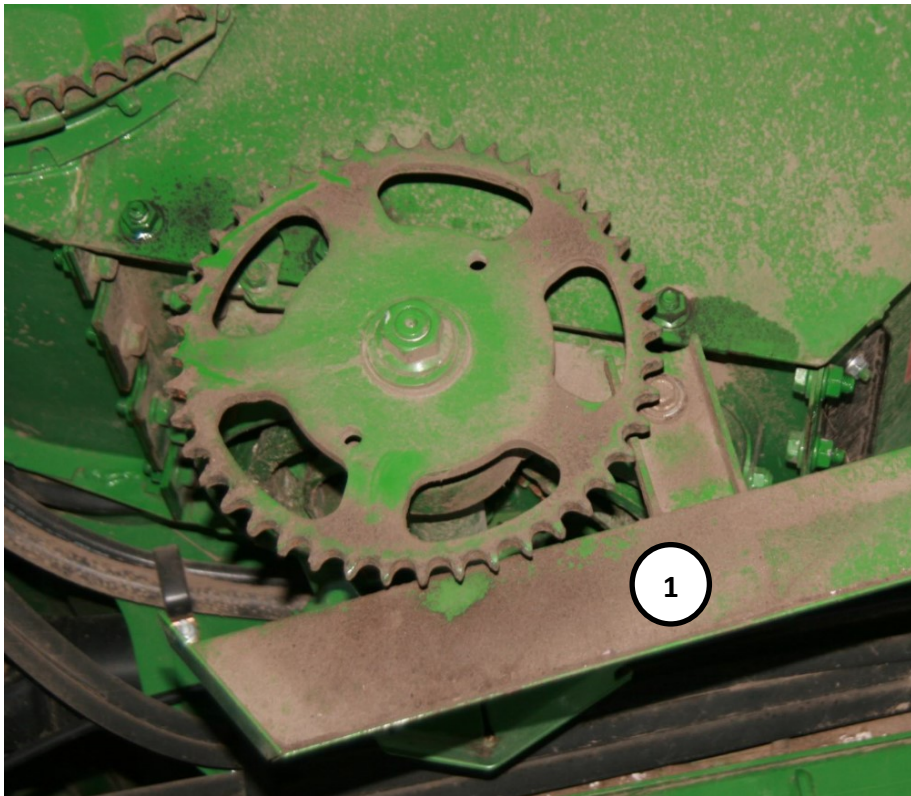

**Figure 1.1**

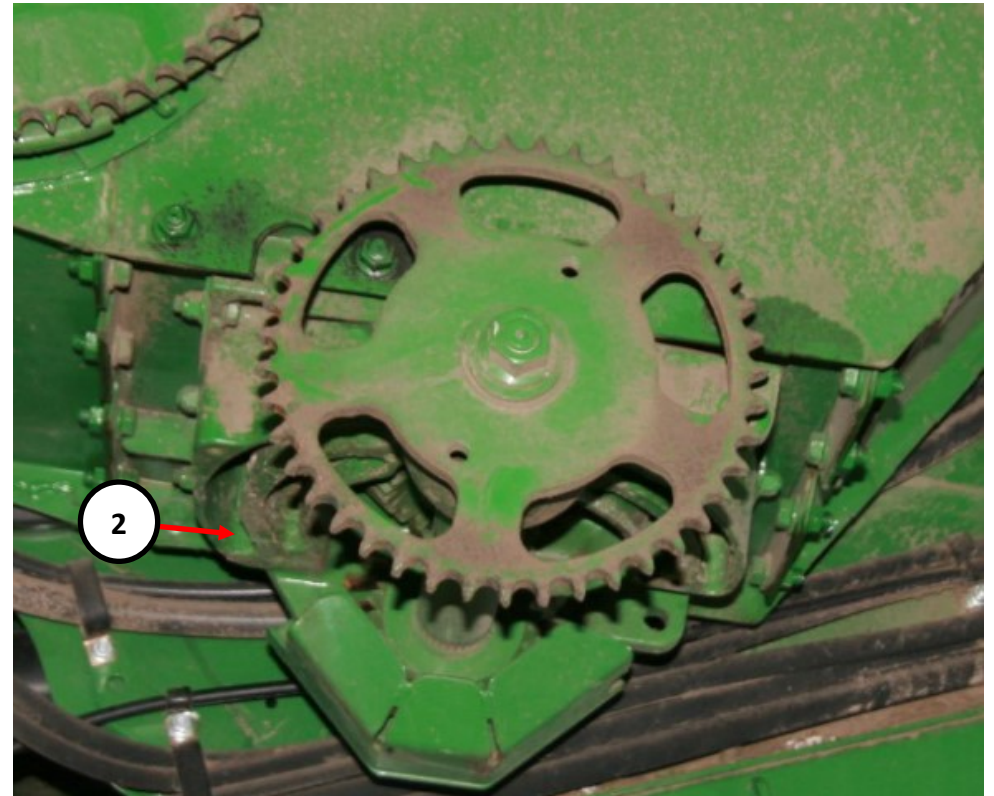
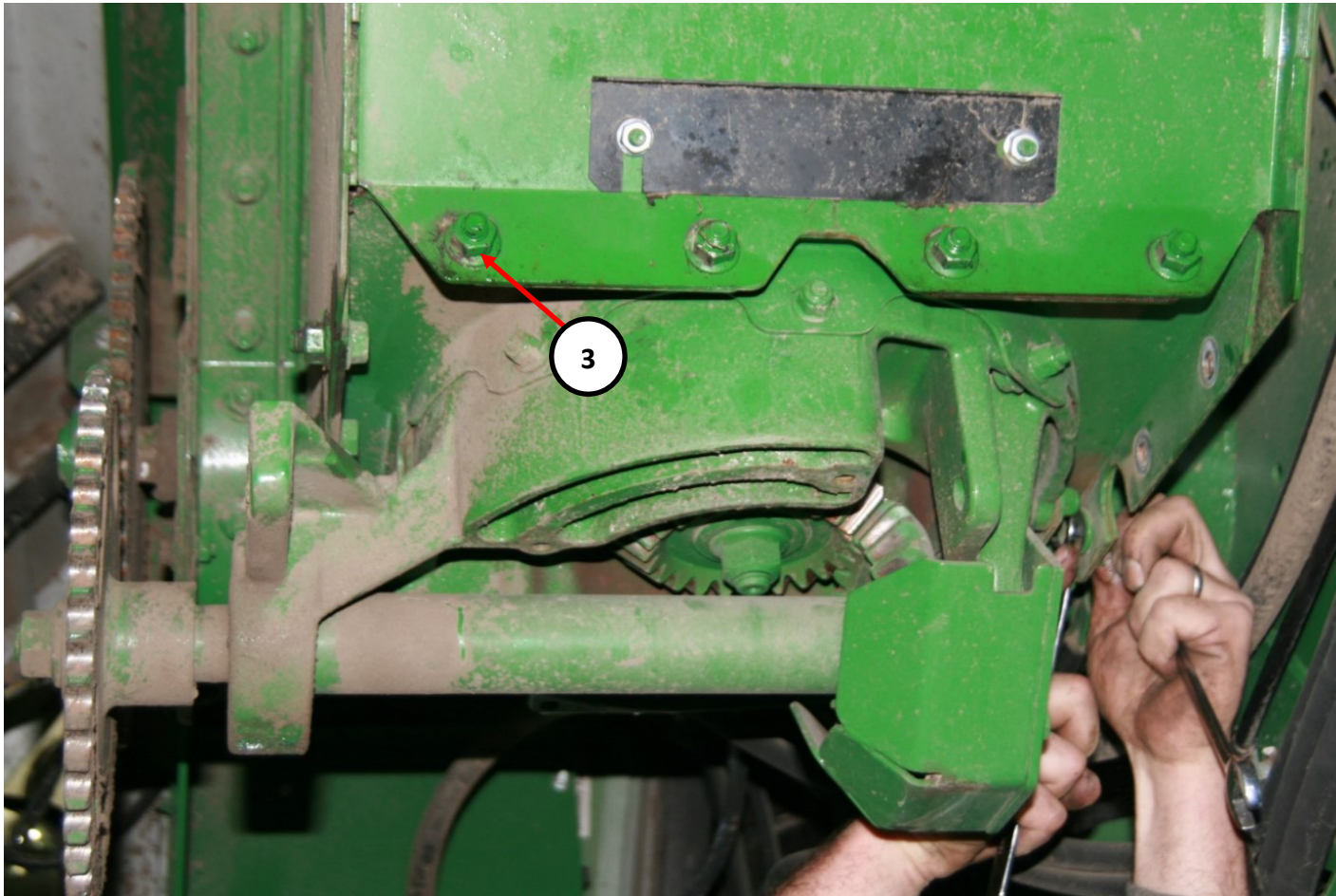

**Figure 1.2**



Refer to Figure 2.1

3. Remove all but one bolt in each corner (4 total) from the gearbox housing area.



**Figure 2.1**

## In Use

### Refer to Figures 3.1 & 3.2

4. Position the cherry picker and auger removal tool so the bolt face of the pivot weldment (LANVRT101) fits up against the bottom of the gearbox. The bolt plate (LANVRT107) will only be used on S680 & S690 combine models.
5. Use the gearbox lower plate bolts to fasten the pivot weldment (LANVRT101) to the bottom of the gearbox. Tighten at this time.
6. Tighten the quick release clamp (LANMINI360QR) at this time to provide resistance while removing the auger. **IT WILL NEED TO BE FAIRLY TIGHT TO PROVIDE PROPER RESISTANCE.**

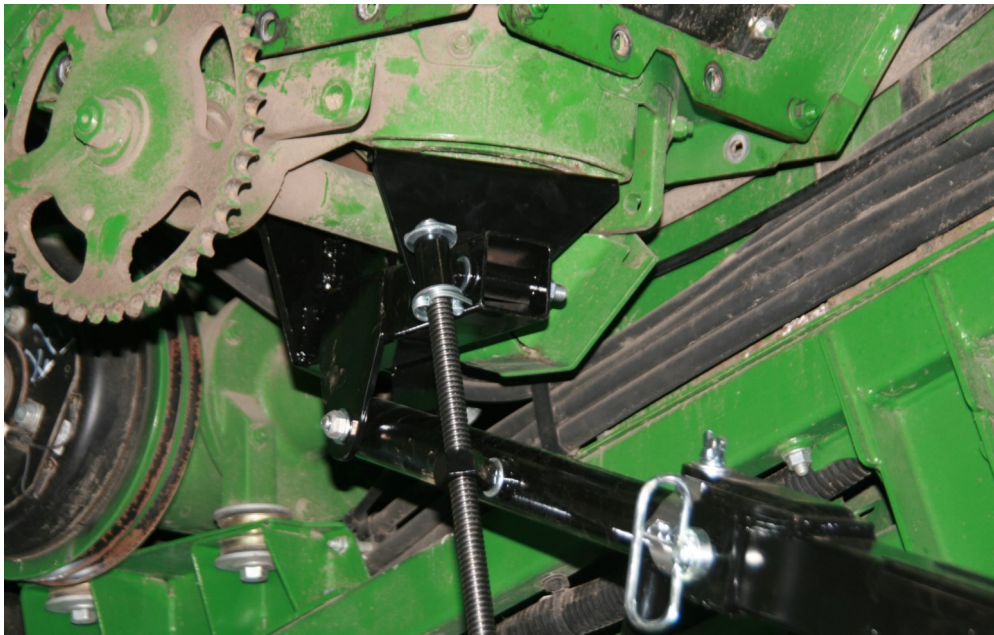

Figure 3.1

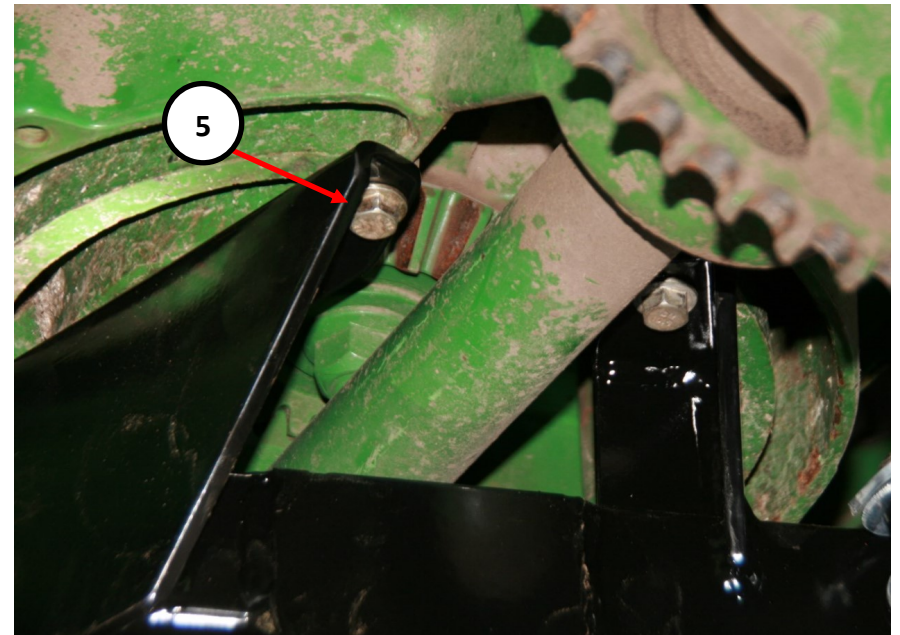

Figure 3.2

## In Use

**Refer to Figure 4.1**

**7. With the auger removal tool securely fastened to the gearbox, remove any remaining bolts holding the gearbox to the combine.**



**Figure 4.1**

## In Use

**NOTE: MAKE SURE THE AUGER COMES DOWN WITH THE GEARBOX! It is NOT fastened to the gearbox so care must be taken to make sure it does not stay in the combine and incidentally fall when the gearbox is removed. FAILURE TO FOLLOW THIS INSTRUCTION COULD RESULT IN SERIES INJURY!**

**Refer to Figures 5.1 & 5.2**

8. Use the cherry picker to lower the gearbox and auger from the combine making sure the auger comes with the gearbox. The threaded rod can be adjusted to keep the auger at the appropriate angle while lowering the gearbox.



**Figure 5.1**

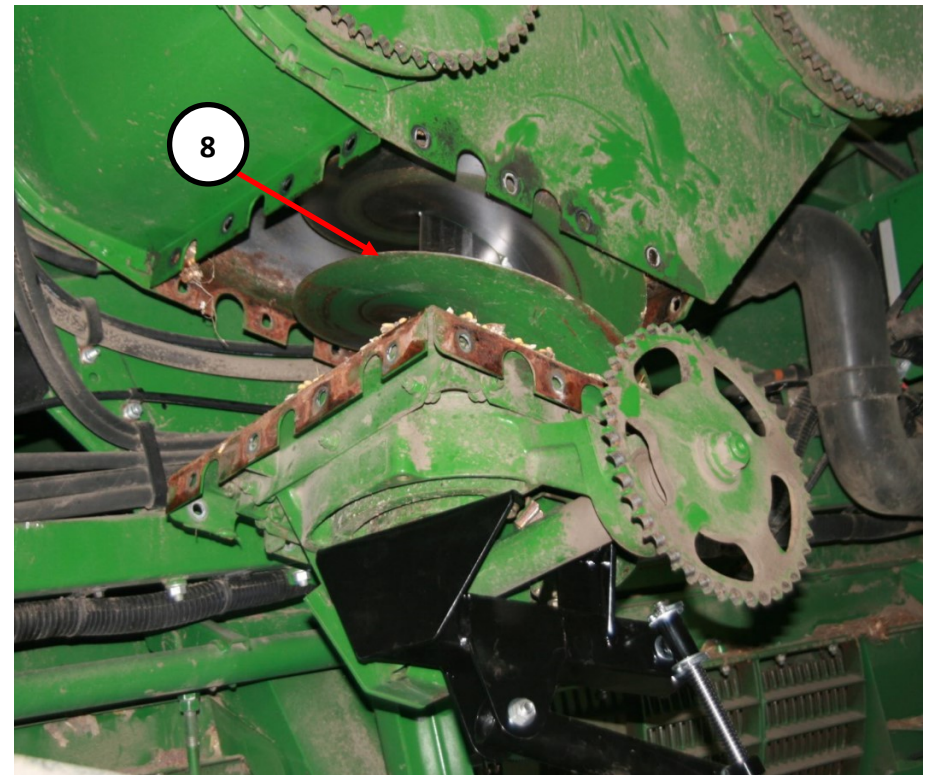

**Figure 5.2**

# In Use

**Refer to Figures 6.1 & 6.2**

9. Continue to lower the gearbox and auger out of the combine, making sure the auger stays with the gearbox. You can then pull the cherry picker away from the combine and do maintenance on the auger/gearbox while still attached to the tool.

**Figure 6.1**



**Figure 6.2**

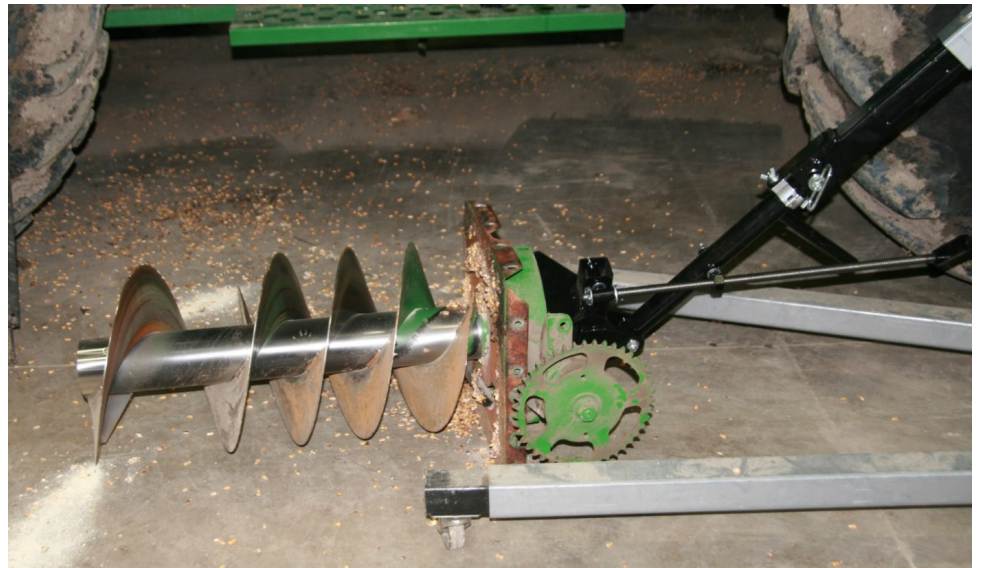

# In Use

**Refer to Figures 7.1 & 7.2**

**10. Remove the seal on the gearbox shaft per the combine manufacturer's procedure and clean up the area.**



**Figure 7.1**



**Figure 7.2**

# In Use

**Refer to Figures 8.1 & 8.2**

11. Install a new seal on the gearbox shaft per the combine manufacturer's procedure.
12. Apply anti-seize to the splines on the gearbox shaft and the inside of the auger and re-install the auger on to the gearbox.



**Figure 8.1**



**Figure 8.2**

# In Use

**NOTE: TIMING OF THE VERTICAL AND HORIZONTAL UNLOAD AUGERS IS VERY IMPORTANT.**

**Refer to Figures 9.1 & 9.2**

13. When looking up into the empty vertical unload auger chute, make sure the horizontal unload auger flighting is facing straight down before proceeding.

14. **CHECK YOUR OWNER'S MANUAL TO MAKE SURE TO GET THE CORRECT AUGER TIMING.** Make a mark on the gearbox sprocket so you have a reference point for where the auger flighting is (Notice in the picture the mark is straight up while the auger flighting is on the opposite side).

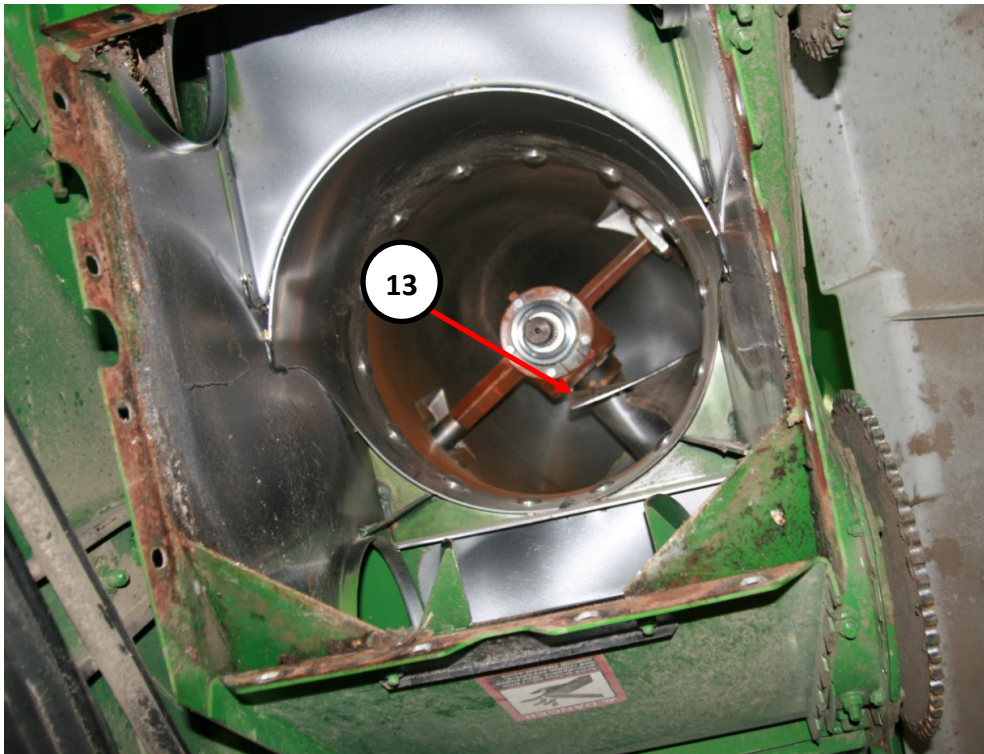

**Figure 9.1**

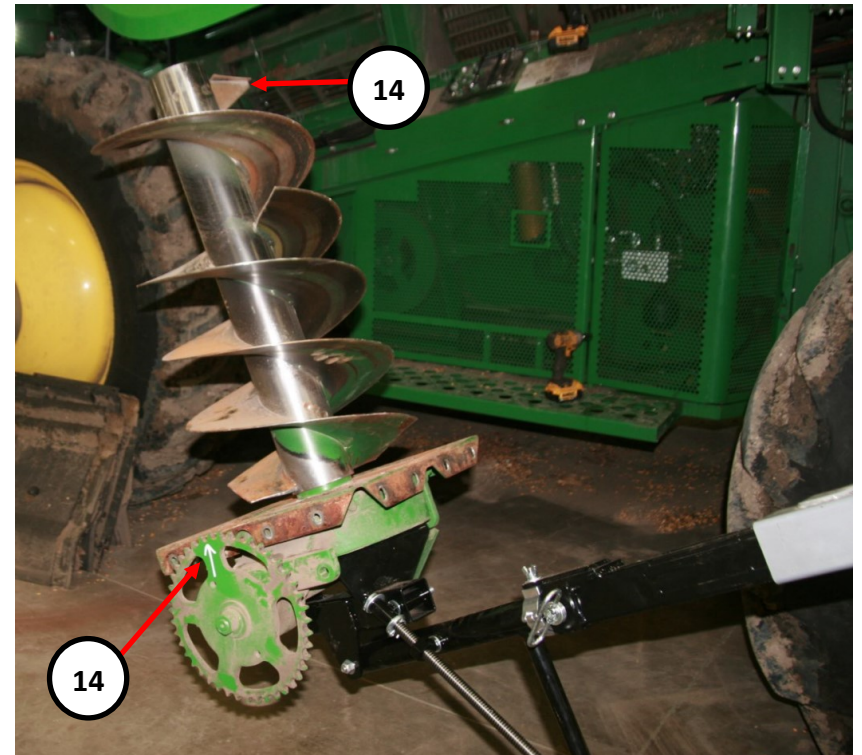

**Figure 9.2**



## In Use

**Refer to Figures 10.1 & 10.2**

**15. Remove the access panel near the pivot point of the horizontal unload auger. This will require the auger to be unfolded slightly. Make sure nobody is on the back of the combine while the combine is running.**



**Figure 10.1**



**Figure 10.2**

## In Use

**Refer to Figure 11.1**

**16. Place the provided plastic wedges (LANVRT108) between the horizontal unload auger flighting and the tube. The purpose of these wedges is to keep the auger from moving while setting the timing of the vertical auger.**



**Figure 11.1**

# In Use

Refer to Figures 12.1 & 12.2

17. Install the auger in the same manner it was removed.

18. Using your reference mark, make sure the auger is timed properly!



Figure 12.1



Figure 12.2

## In Use

**Refer to Figures 13.1 & 13.2**

**19. Once the auger and gearbox are in place, re-install all the bolts to hold the gearbox into the combine.**

**20. You can now remove the plastic wedges (LANVRT108) from the horizontal unload auger and replace the cover.**



**Figure 13.1**



**Figure 13.2**

Refer to Figure 14.1

21. Remove the auger removal tool from the combine and re-install the gearbox cover plates.



**Figure 14.1**

# Maintenance

1. Be sure to periodically apply a small amount of light lubricant to the threaded rod of the tool. This will help prolong the life of the tool and ensure ease of use.
2. If any parts begin to show wear, stop use immediately and contact Lankota for assistance.



**For further technical assistance,  
call Lankota Inc. at:  
1-866-526-5682**