

LANUDJD4000K

Installation Instructions

Unloading Auger Electric Clutch Disengage System

John Deere® 00, 10 & 50 Series Walker Combines

The initial burnish process of the clutches contained in this kit has been performed by Lankota prior to shipment.

LANKOTA®

270 West Park Avenue

Huron, SD 57350

866-526-5682

Warnings

- Do NOT use with automatic lubrication system
- Clutches must have a continuous 12V or more when in use to operate properly
- Wiring MUST be grounded directly to the battery
- Clean out grain tank sump drain WEEKLY
- After several days of non-use, re-burnish clutches using the method described in the back of the manual
- NEVER leave wet grain in grain tank

FAILURE TO FOLLOW THESE WARNINGS WILL VOID ANY AND ALL WARRANTIES, IMPLIED OR EXPRESSED.

Numerical Parts List

Part Number	Description	Qty.
LANUDJD1001	Shaft Drill Jig	1
LANUDJD4100	Clutch Alignment Flex Bracket	1
LANGT5C-LK01	Electro Magnetic Clutch - REAR	1
LANGT5C-LK02	Electro Magnetic Clutch - FRONT	1
LAN60A49	#60, 49 Tooth Sprocket	2
LANUDJD3004	Door Latch Bracket	1
LANUDJD3005	Front Door Bracket	1
LANUDJD3006	Rear Door Bracket	1
LANUDJD4010	Rear Door Stop	1
LANUDJD4011	Door Latch Bracket	1
LANUDJD4012	Front Door Stop - Bolt Plate	1
LANUDJD4013	Front Door Stop	1
LANUDJD1004	Sprocket Shim	6
LANFHKGV5	Key—8 x 10 x 40mm	2
CABAS1536	Rubber Molding	1







Numerical Parts List

Part Number	Description	Qty.
LANUDJDBH	Bag Of Hardware	1
-----	25/64" Drill Bit	1
-----	7/16" Lock Washer	2
-----	7/16" x 2" Grade 5 Bolt	2
-----	7/16"-14 Drill Tap	1
-----	M8-1.25 x 25mm, Grade 8.8 Bolt	16
-----	M8 Lock Washer	12
-----	M8 Nyloc Nut	4
-----	5/16" SAE Flat Washer	8
-----	11" Zip Tie	10
-----	3/8"-16 x 3/4" Carriage Bolt	2
-----	3/8"-16 x 1" Bolt	3
-----	3/8" Serrated Flange Nut	5
-----	5/8" Washer	10
LANHT9260	Wiring Harness Bundle	1
-----	Cab Extension Harness	2
-----	Power Harness	1
-----	Cab Foot Switch	1
-----	Clutch Harness	1
-----	Wiring Harness Bundle Hardware Bag	1

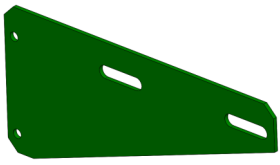
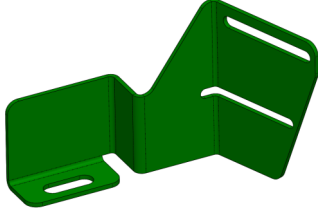
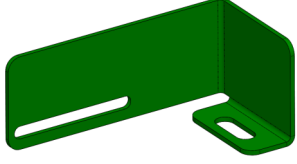
Pictorial Parts List

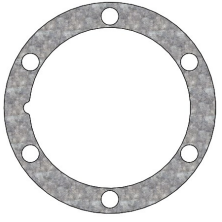
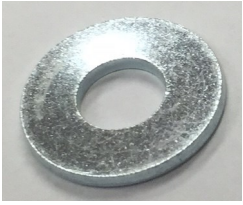
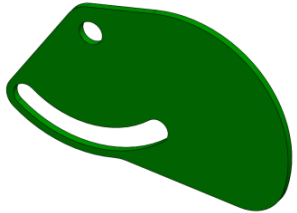
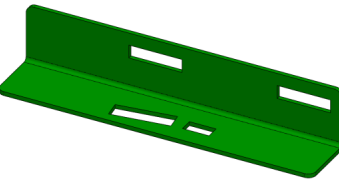
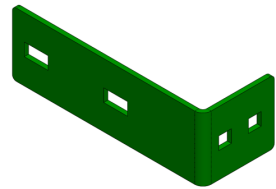
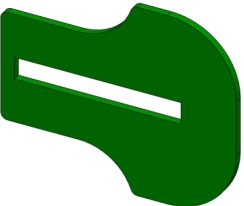
				
LANUDJD1001	LAN60A49 (2)	LANGT5C-LK01 (1)	LANGT5C-LK02 (1)	8x10 x 40mm Key (2)
				
Cab Extension Harness	Power Harness	Clutch Harness	Cab Foot Switch	Wiring Kit Bag of Hardware
				
LANUDJD4100 (1)	M8 Lock Washer (12)	7/16" Lock Washer (2)	7/16"-14 Tap	25/64" Drill Bit
				
M8-1.25 X 25mm, Gr 8.8 Bolt (16)	M8 Nyloc Nut (4)	5/16" SAE Flat Washer (8)	7/16" x 2" Grade 5 Bolt (2)	11" Zip Tie (10)

Pictorial Parts List

				
LANUDJD3004 (1)	LANUDJD3005 (1)	LANUDJD3006 (1)	3/8" x 3/4" Carriage Bolt (2)	LANUDJD1004 (6)
				
5/8" SAE Flat Washer (10)	LANUDJD4010 (1)	LANUDJD4011 (1)	LANUDJD4012 (1)	LANUDJD4013 (1)
				
CABAS1536	3/8" Serrated Flange Nut (5)	3/8" x 1" Hex Bolt (3)		

Preparation

Refer To Figure 1.1

1. Open L/H main access door on combine, exposing the unloading auger drive chain system.
2. Loosen drive chain tensioner completely.
3. Remove drive chain; let it hang from rear main drive sprocket or set it aside for later reinstallation.
4. Remove both grain tank cross auger drive sprockets from auger shafts. Leave bearing locking collar and square shaft key installed on shafts just as they are. **DO NOT TRY TO REMOVE BEARING LOCKING COLLAR FROM SHAFT!**
5. Use emery cloth to clean any scuffs, burs or paint from end of shaft. This will make installation of new components much easier.

Figure 1.1



1. Clutch & Sprocket Installation

Refer To Figure 1.2

1. Locate the 25/64" Drill Bit that is supplied in the bag of hardware. Measure from the cutting end of the drill bit back towards the shank 3" inches and make a visible mark.
2. Slide Shaft Drill Jig (LANUDJD1001) over the end of front exposed auger shaft. Make sure jig is on all the way.

Refer To Figure 1.3

3. Using the jig as a guide, drill into the end of the shaft deep enough so that your 3" mark is flush with the end of the Shaft Drill Jig. **MAKE SURE YOU DRILL AT LEAST THIS DEEP. IF YOU DRILL DEEPER THAT IS OK—Use light machine oil to assist with the drilling and keep the bit cool.**
4. Repeat these steps for the second, rear auger shaft.
5. Remove Shaft Drill Jig from shaft. You will no longer use this jig.

Figure 1.2



Figure 1.3

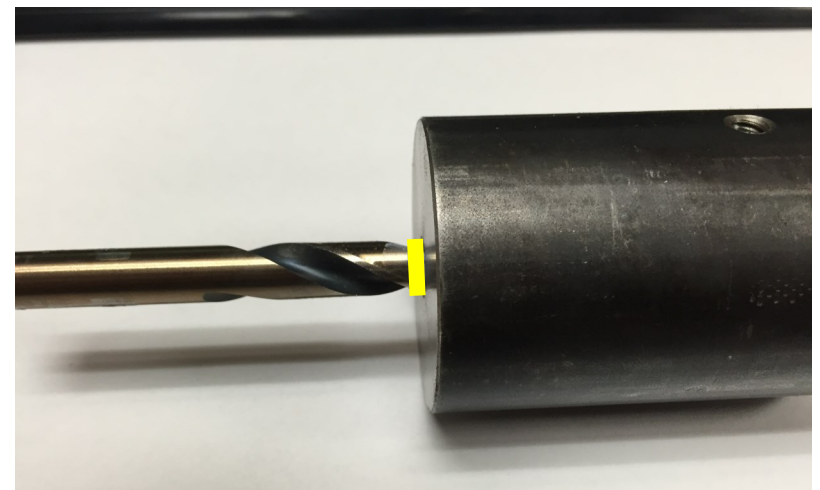

1. Clutch & Sprocket Installation

Refer To Figure 1.4

6. Use a pipe wrench or equivalent to hold auger shaft from turning while tapping the drilled hole. Locate the 7/16" Tap supplied in the hardware bag and tap the holes drilled in both auger shafts. Make sure the threads are a minimum 1-1/4" deep.
7. Use a cutting oil or spray lubricant if possible to get the best thread results.

Figure 1.4



1. Clutch & Sprocket Installation

Refer To Figure 1.5

NOTE: Put at least two shims (LANUDJD1004) between each clutch and sprocket to ensure bolts can be tightened properly.

8. Locate twelve of the M8-1.25 x 25mm, Grade 8.8 Bolts and twelve of the M8 Lock Washers from the supplied bag of hardware. Attach a #60, 60 Tooth Sprocket (LAN60A60) to the Electro Magnetic Clutch (LANGT5C-LK01) using six bolts and lock washers - This will go on the **REAR CROSS AUGER**.
9. Attach another sprocket to the Electro Magnetic Clutch (LANGT5C-LK02) using the remaining fasteners - This will go on the **FRONT CROSS AUGER**.

NOTE: Bolts may be tightened at this time.



Figure 1.5

1. Clutch & Sprocket Installation

Refer to Figure 1.6 & 1.7

NOTES:

- Shims (LANUDJD1004) are provided to bolt between the clutch and sprocket and 5/8" washers are provided to place between the clutch and auger shaft. *NOTE: The installer needs to make sure all sprockets run on the same plane and line up with the chain properly.*
 - It is **STRONGLY** recommended that anti-seize be applied to the auger shaft before installing the clutch & sprocket assembly.
 - Use a small amount of thread locking compound on each bolt to secure clutch/sprocket assembly to drilled shafts.
 - Use either the factory or provided key(s) for proper clutch/shaft engagement. You may need some light sanding to properly fit the key.
10. Install both front and rear clutch/sprocket assemblies onto drilled auger shafts using one 7/16" x 2" Grade 5 Bolt with thread locking compound and one 7/16" Lock Washer per shaft. Torque the bolt to 50-55 ft-lbs.
 11. Re-install the unloading system chain on the new sprocket/clutch assemblies.

Figure 1.6

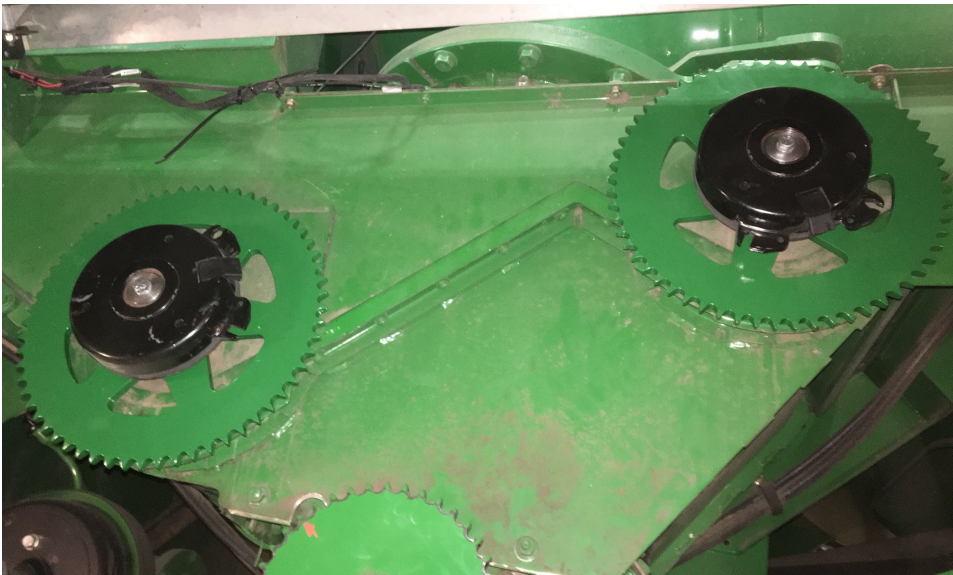
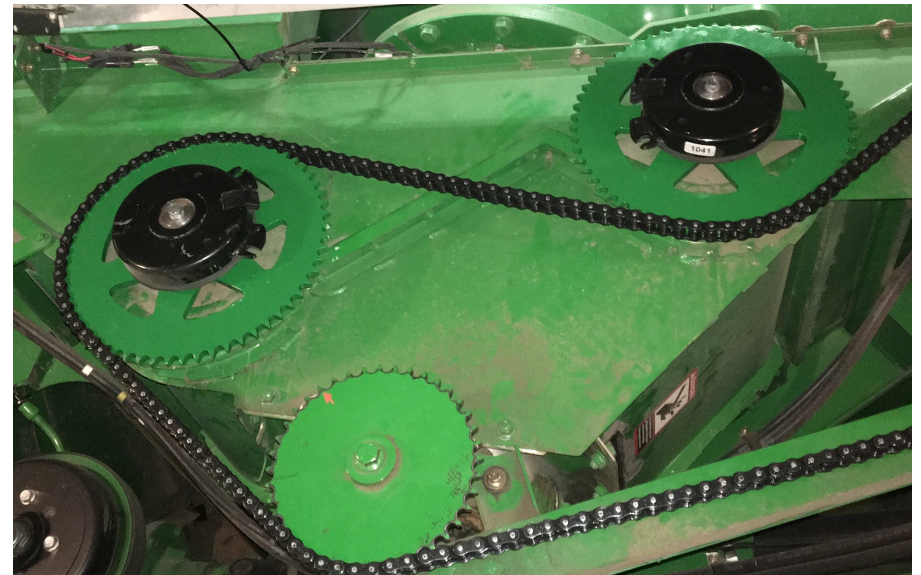

Figure 1.7



1. Clutch & Sprocket Installation

Refer to Figure 1.8

12. Locate four M8-1.25 x 25mm, Grade 8.8 Bolts, four M8 Nyloc Nuts and eight 5/16" SAE Flat Washers from the supplied bag of hardware and use to attach Clutch Alignment Bracket (LANUDJD3002) to both front and rear clutch assemblies. Tighten at this time.
13. Tighten the unload drive chain as outlined in the COMBINE OPERATOR'S MANUAL.



Figure 1.8

2. Rear Wiring Harness Installation

Refer to Figure 2.1

1. Open the wiring harness box and unpack.

Figure 2.1

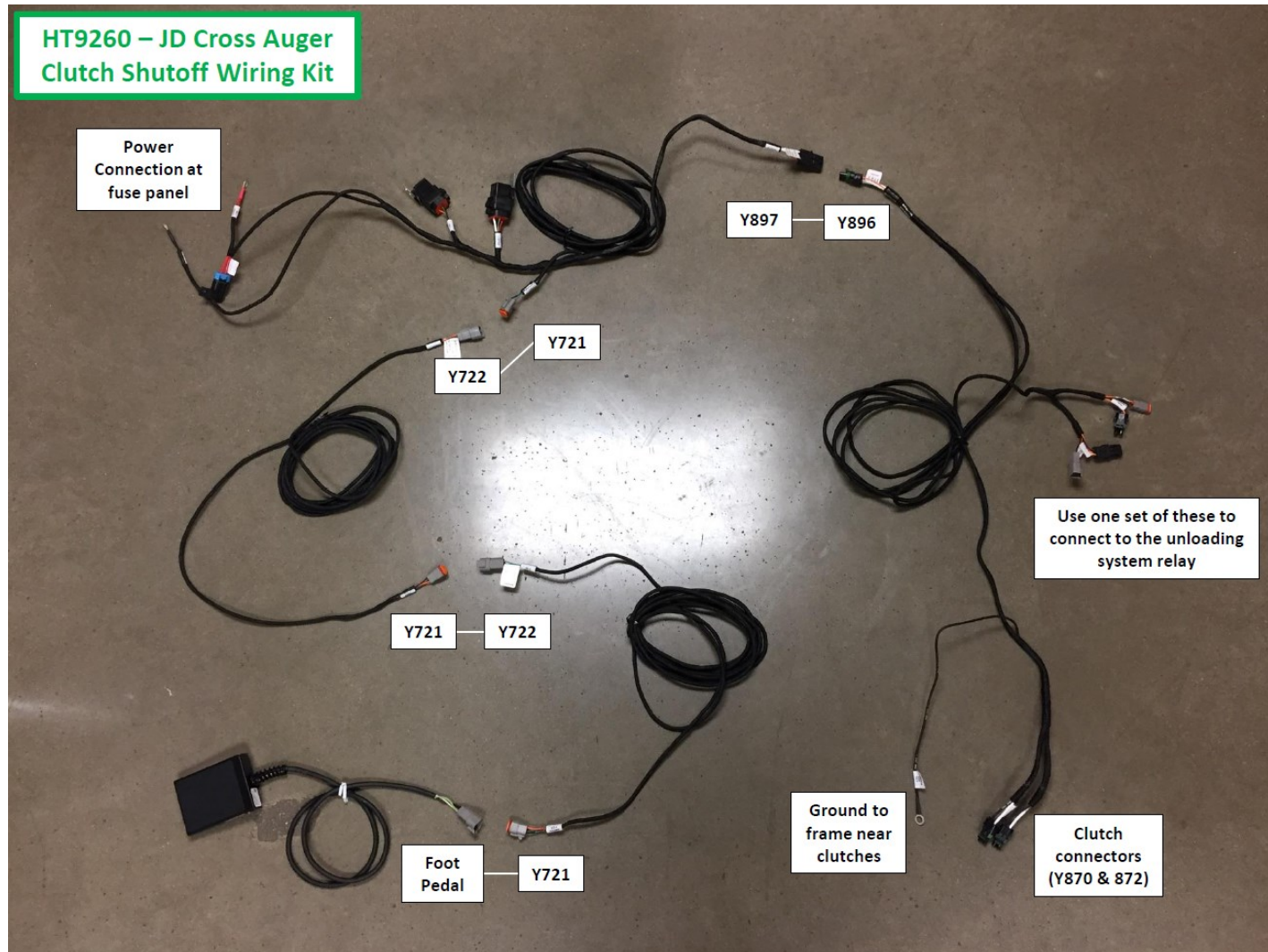

2. Rear Wiring Harness Installation

Refer to Figures 2.2 - 2.4

2. Identify the power cable and connect the red wire to the battery cable terminal. This may look different depending on your model of combine - see Figures 2.2a - 2.2c.

Figure 2.2a



Figure 2.2b

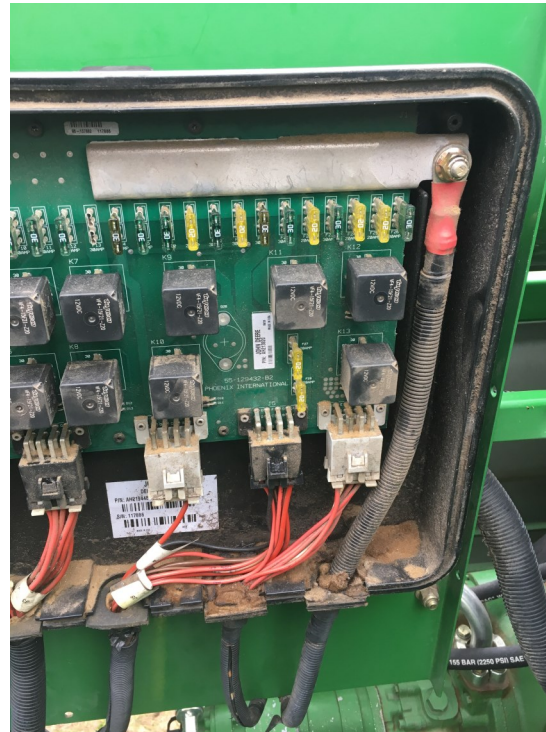

Figure 2.2c



2. Rear Wiring Harness Installation

Refer to Figures 2.3 & 2.4

3. Attach the relays near the fuse panel using the included attachment plate and existing hardware.
4. Connect the ground wire to the negative battery terminal.

Figure 2.3



Figure 2.4



2. Rear Wiring Harness Installation

Refer to Figures 2.5 & 2.6

5. Connect one of the cab extension cords to the power cable.
6. Run the ends of the two cords together across the combine, under the rotor drive belt and on top of the sieve.

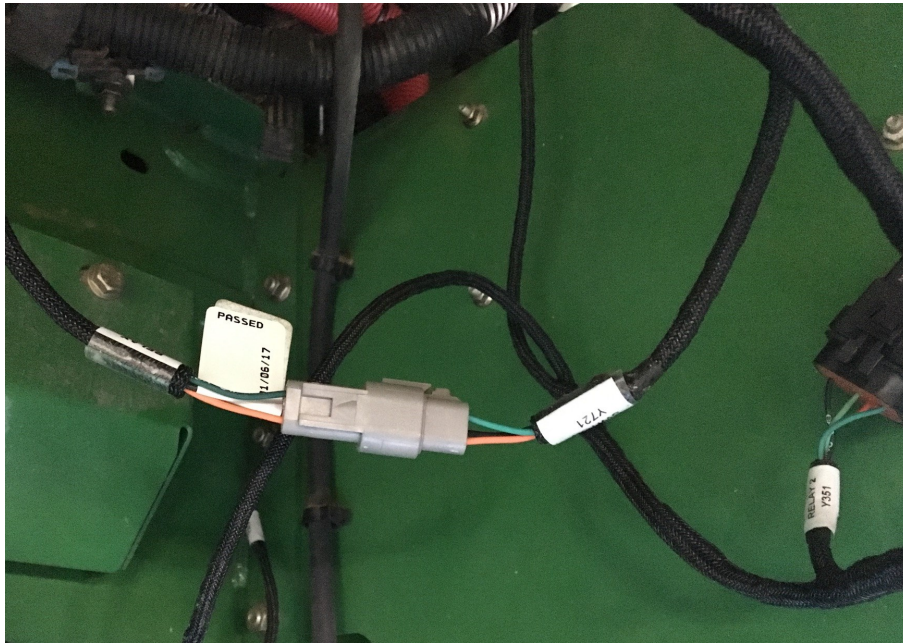

Figure 2.5



Figure 2.6

2. Rear Wiring Harness Installation

Refer to Figure 2.7

The supplied wiring harness has two different style connector ends to fit many different model combines. Choose either the black connectors or the gray connectors that match your combines connectors.

7. Retrieve the clutch connecting wiring harness.
8. Access the engine compartment.
9. Locate the unloading auger solenoid wiring connectors on the left side of the engine.

Figure 2.7



2. Rear Wiring Harness Installation

Refer to Figure 2.8 & 2.9

The supplied wiring harness has two different style connector ends to fit many different model combines. Choose either the black connectors or the gray connectors that match your combine's.

10. Loosen protective covering on L/H solenoid.

11. Disconnect **L/H ONLY** wiring connectors as shown in Figure 2.3.

Figure 2.8



Figure 2.9

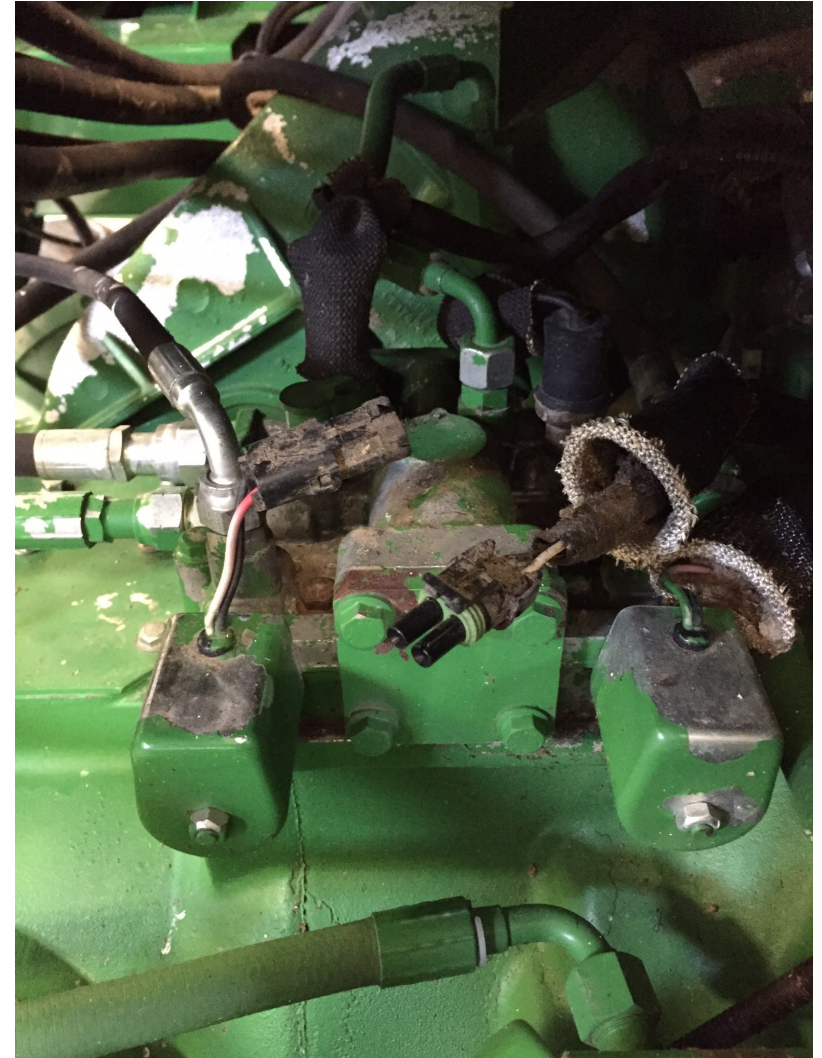

2. Rear Wiring Harness Installation

Refer to Figure 2.10

12. Connect either the black connectors or the gray connectors of the wiring harness to the connectors on the combine. Whichever connectors do not get used, connect those together as shown in the picture shown by the yellow arrow.
13. Replace wiring harness protective cover previously removed. Secure with a zip tie.

Route wiring harness as shown in the next figures. Secure harness as needed using supplied bag of hardware that came in the wiring bundle and/or the supplied zip ties.

Figure 2.10



2. Rear Wiring Harness Installation

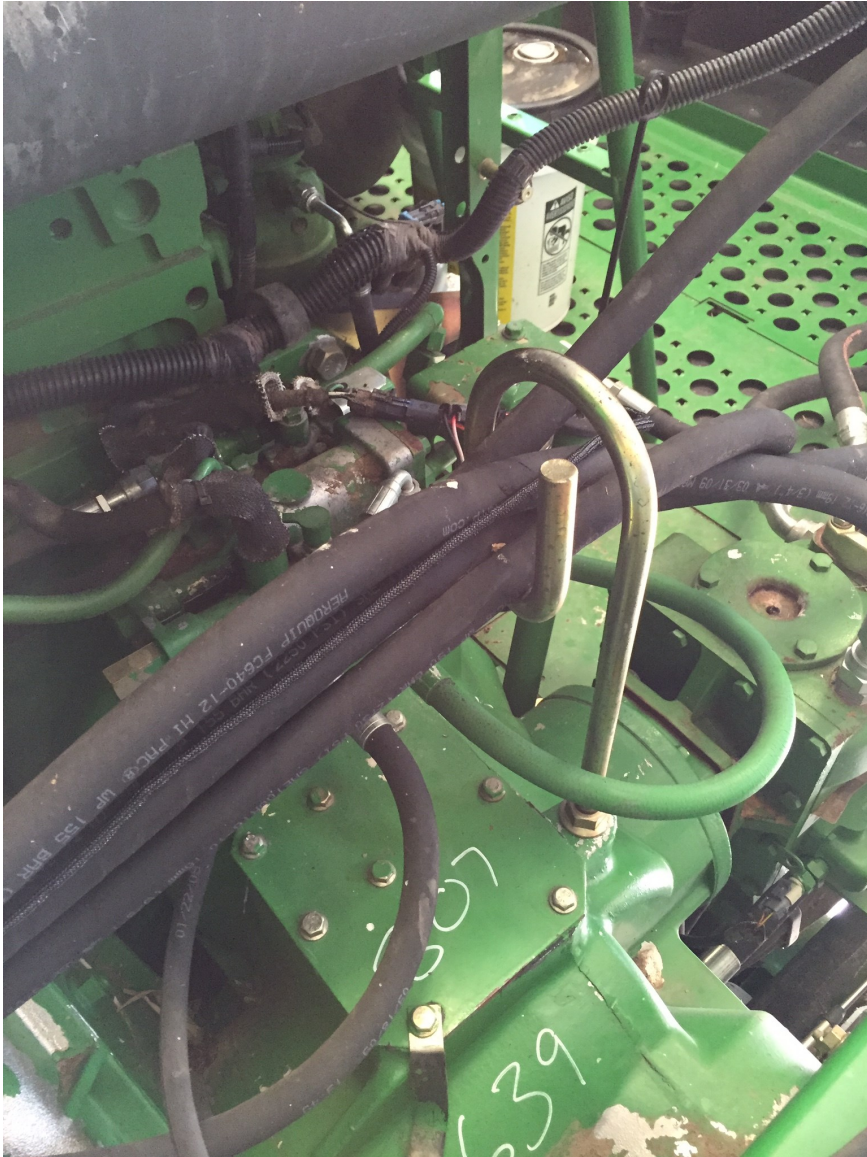

2. Rear Wiring Harness Installation



Clutch Connector
Wiring Harness

Cab Extension
Cable

Power Cable
Wiring Harness

2. Rear Wiring Harness Installation



2. Rear Wiring Harness Installation



Figure 2.11

Refer to Figures 2.11 & 2.12

14. Attach grounding cable to frame (ensure a good connection).
15. Route the clutch harness to the clutches and plug into the clutch wire leads.
16. Secure harness with zip ties as to avoid any damage.

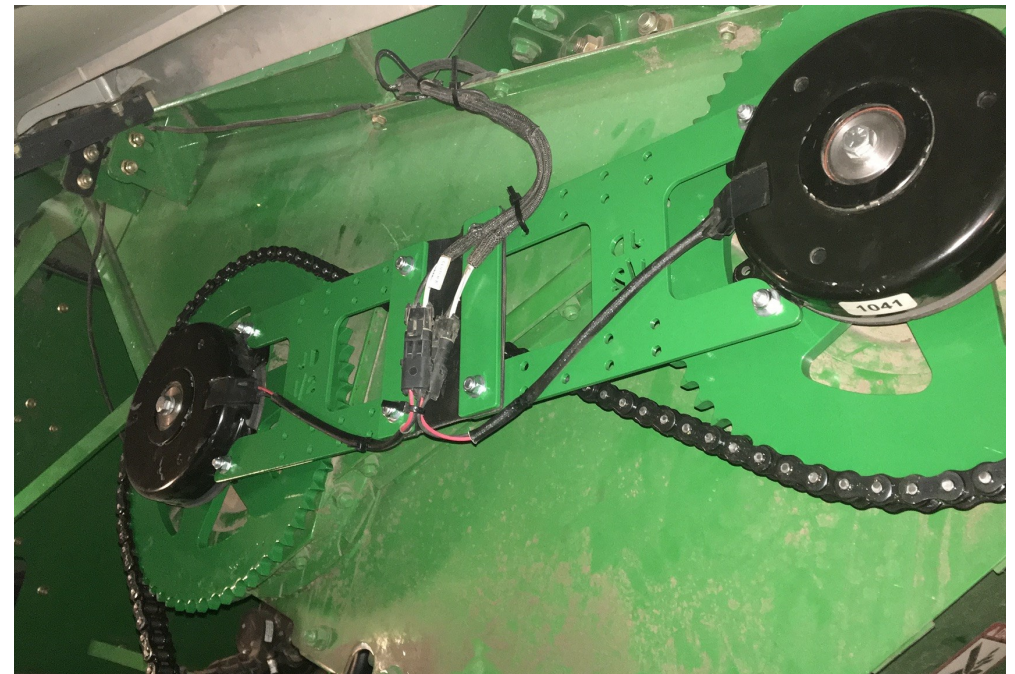

Figure 2.12

3. Cab Wiring Harness Installation

Refer to Figures 3.1 & 3.2

1. Retrieve second cab extension wiring harness and connect it to the first as shown.
2. Attach harness where you can to avoid any damage during operation of combine and/or opening and closing of the side shield.



Figure 3.1

Figure 3.2



3. Cab Wiring Harness Installation

Refer to Figure 3.3 & 3.4

3. Open lower access door just outside of the combine cab door at the top of the ladder landing.
4. Route harness as shown in Figure 3.3. Secure where you can with zip ties.
5. Loop any extra wire here.

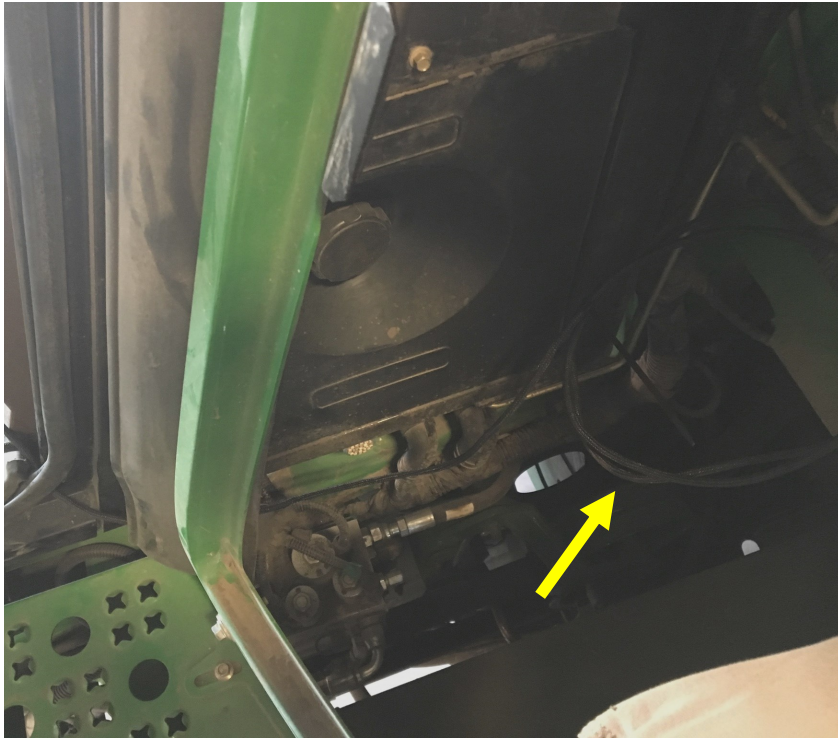

Figure 3.4

Figure 3.3



3. Cab Wiring Harness Installation

Refer to Figure 3.5A

6. Run harness through bottom of door frame as shown. Notice harness under door seal.

Refer to Figure 3.5B

7. It is recommended to grind out a small amount of material from the door frame so the harness does not experience a tight bend and rub on the metal over time causing the harness to fail.

Figure 3.5A



Figure 3.5B



3. Cab Wiring Harness Installation

Refer to Figure 3.6

8. Remove cab door bottom threshold cover by removing the three recessed bolts.
9. Pull up floor mat of combine cab just in front of passenger and operator seat. Run harness under floor mat to the far R/H side of the cab.
10. Connect Floor Pedal Harness to the cab extension cord. Place in cab where desired. Route cord as best as possible to avoid congestion with feet and brake pedals.



Figure 3.7

Figure 3.6



4. Door Bracket Installation - 30** Brackets

In some instances the side of the combine may come in contact with the clutches when closed. Replacement door brackets are provided to space the door out an appropriate amount in the front, back, and at the latch area of the door.

Refer To Figures 4.1 & 4.2

1. Open the door and remove the middle door latch and bracket plate.
2. Replace plate with LANUDJD3004 as shown and reattach to combine. Adjust it so that the door still latches properly but does not come into contact with any portion of the clutches.

Figure 4.1



Figure 4.2



4. Door Bracket Installation - 30** Brackets



Figure 4.3a



Figure 4.3b

Refer To Figures 4.3 - 4.4

3. Remove the rear door catch plate from the combine.
4. Remove the magnetic cup from the door.



Figure 4.4a



Figure 4.4b

4. Door Bracket Installation - 30** Brackets

Refer To Figures 4.5

5. Replace rear plate with LANUDJD3006 as shown and reattach to combine. Adjust the plate so that the door rests firmly against it when latched.

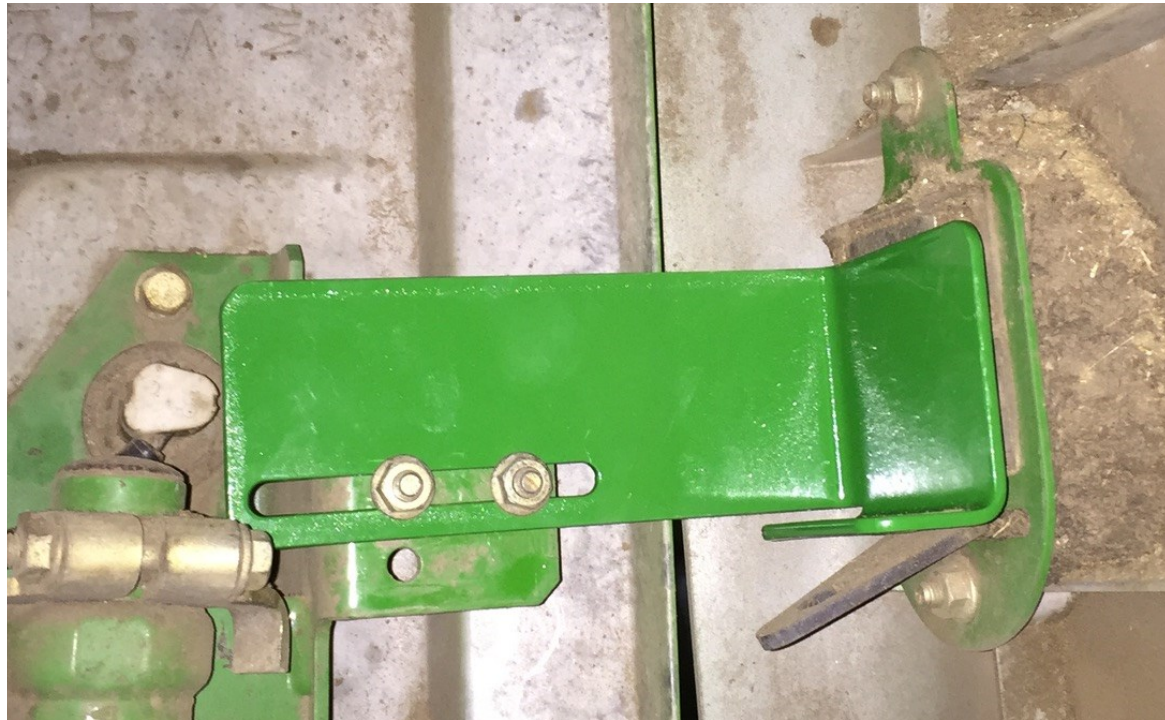

Figure 4.5

4. Door Bracket Installation - 30** Brackets

Refer To Figures 4.6 - 4.8

6. Remove the front door bracket.
7. Replace with LANUDJD3005. Adjust it so that the door rests firmly against it when latched.



Figure 4.6



Figure 4.7



Figure 4.8

4. Door Bracket Installation - 40** Brackets

Refer To Figures 4.9 & 4.10

1. Remove the rear door latch spring from the door latch.

Figure 4.9



Figure 4.10



4. Door Bracket Installation - 40** Brackets



Figure 4.11

Refer To Figures 4.11 - 4.13

2. Remove the rear door catch plate from the combine and, with existing hardware, replace with LANUDJD4011.
3. Use existing hardware to install the door latch spring on to LANUDJD4011.
4. Adjust accordingly to ensure the door latches properly and does not contact the clutches when latched.

Figure 4.13



Figure 4.12



4. Door Bracket Installation - 40** Brackets



Figure 4.14

Refer To Figures 4.14 - 4.16

5. On the face of the combine platform outside the cab door, measure out and mark two spots drill $7/16$ " holes. They need to be $1-1/4$ " up from the bottom side of the platform, spaced $2-1/2$ " and the first hole should be $11/16$ " away from the back edge of the platform. **For reference, the LANUDJD4012 bracket will need onto the inside of the platform.**
6. Fasten LANUDJD4012 to the platform using (2) $3/8$ " x 1" hex bolts (LAN18A00) and (2) $3/8$ " serrated flange nuts (LAN3718).

Figure 4.15

Figure 4.16

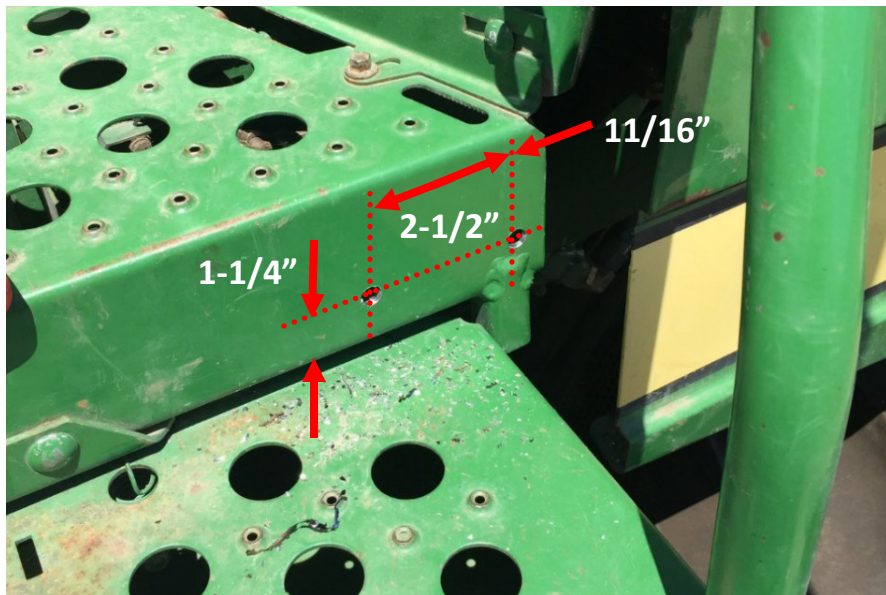

4. Door Bracket Installation - 40** Brackets

Refer To Figures 4.17 & 4.18

7. Bolt the part number LANUDJD4013 to LANUDJD4011 using two 3/8" x 3/4" carriage head bolts (LANFK303) and two 3/8" serrated flange nuts (LAN3718).
8. Cut a piece of rubber molding (CABAS1536) and put it over the edge of the LANUDJD4013 that will contact the door. Adjust the bracket so that the door rests firmly against it when latched.



Figure 4.17



Figure 4.18

4. Door Bracket Installation - 40** Brackets

Refer To Figure 4.19

9. At the rear of the door, on the stationary panel, remove and save the bolt that holds the strut to the bottom of the panel.
10. Install the LANUDJD4010 bracket using one of the provided 3/8"-16 x 1" hex head bolts (LAN18A00). Re-install the bolt removed in the previous step, making sure it holds on the strut and goes through the slot in the LANUDJD4010.
NOTE: If there is no hole for the top bolt, drill a 7/16" diameter hole 2" directly above the bolt removed in step 9.
11. Cut a piece of rubber molding (CABAS1536) and put it over the edge of the LANUDJD4010 that will contact the door. Adjust the bracket so that the door rests firmly against it when latched.

Figure 4.19



FOOT SWITCH Y721					
PIN	CIR #	LABEL	COLOR	GA	TYPE
A	001	GROUND	BLK	18	TXL
B	725	AUX SWITCH	DK GRN	18	TXL
C	719	12VENABLE	ORG	18	TXL

RELAY ASSM Y722					
PIN	CIR #	LABEL	COLOR	GA	TYPE
A	001	GROUND	BLK	18	TXL
B	725	AUX SWITCH	DK GRN	18	TXL
C	719	12VENABLE	ORG	18	TXL

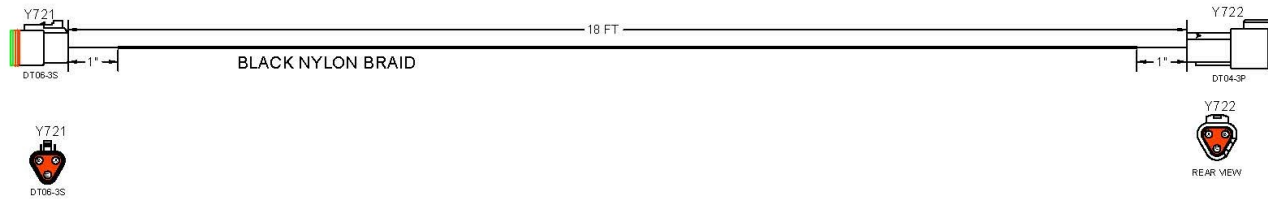

- 2 TXL WIRE INSULATION MAY NOT EXCEED 0.078" (2MM) DIA.
- 1 LABEL EACH CONNECTOR WITH PART ID AND NAME

ID LABEL	
OWNER	HEADSIGHT, INC
ITEM	SEE SHEET PART NUMBER
REVISION	SEE SHEET REV. #
DATE	BUILD DATE
MFG	SUPPLIER NAME

COMPONENT DATA

ITEM	PART ID	QTY	DESCRIPTION	MFG	MFG P/N	TERMINAL P/N	ACCESSORY P/N	ACCESSORY P/N
1								
2	Y721	1	CONN, 3p PLUG	DEUTSCH	DT06-3S	0462-201-16141		WSS
3	Y722	1	CONN, 3p RCPT	DEUTSCH	DT04-3P	0460-202-16141		WSP
4								
5								
6								
7								
8								
9								
10								

NOTES:
 FOOT SWITCH EXTENSION
 1 NEEDED FOR 9x70--S
 2 NEEDED FOR 9x00-9x50

REVISIONS			
REV	DESCRIPTION	DATE	APPROVED
1	CREATED PART	12.2.16	JHK
2	CORRECTED BLACK-A, ORG-C	01.04.17	JHK



DRAWN 1/4/2017
 DRAWN BY: JHK

FILE NAME
 HT9260-FS
 CABLE LAYOUT

PART NUMBER HT9260-FS	REV 2
--------------------------	----------

SCALE NOT TO SCALE SHEET 01



NOTES:

REVISIONS

REV	DESCRIPTION	DATE	APPROVED



FILE NAME

HT9260-FS R2
WIRING SCHEMATIC

DRAWN 1/4/2017

DRAWN BY: JHK

PART NUMBER

HT9260-FS

REV 2

SCALE NOT TO SCALE

SHEET 02

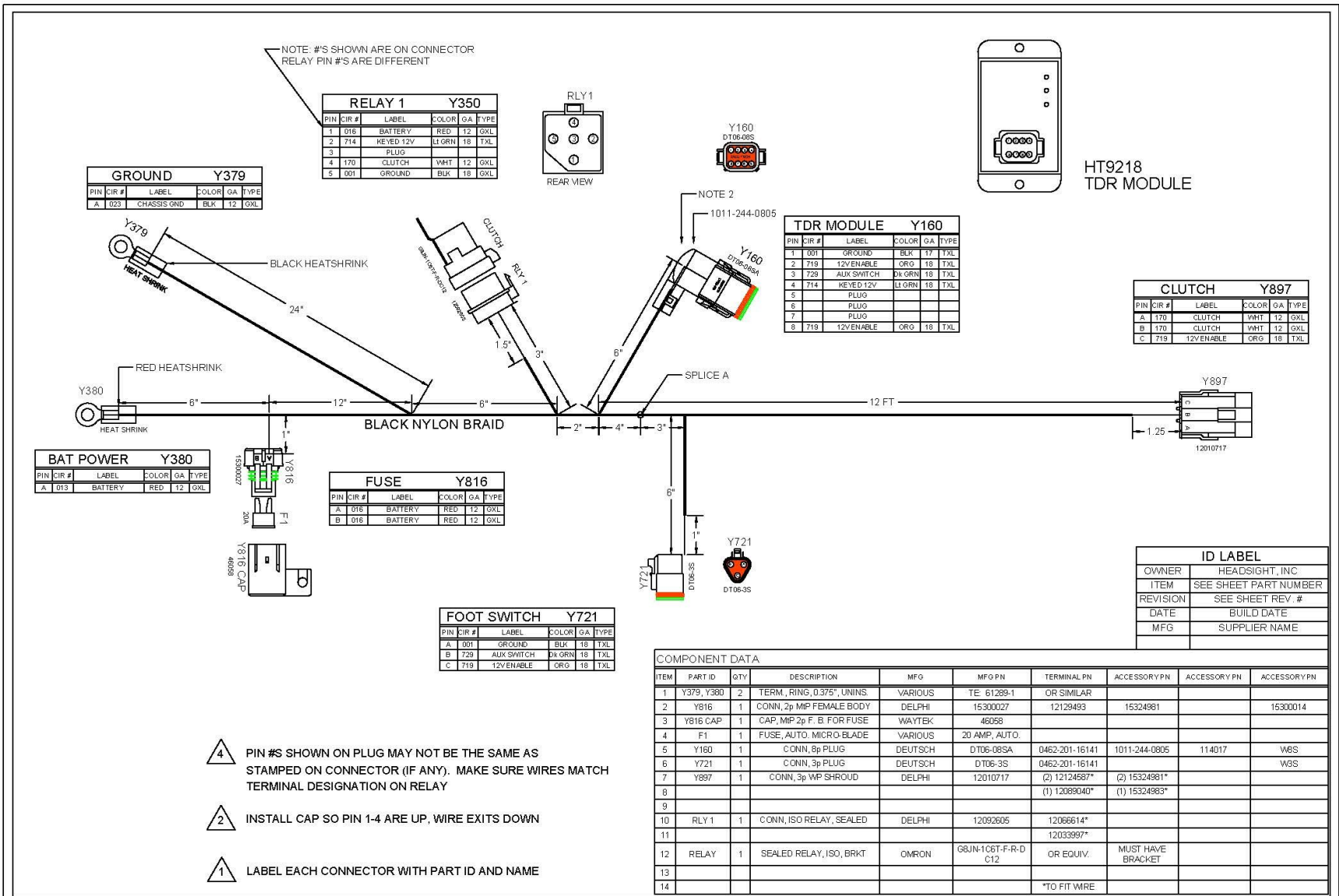

RELAY 1 Y350				
PIN CIR #	LABEL	COLOR	GA	TYPE
1	BATTERY	RED	12	GXL
2	KEYED 12V	LI GRN	18	TXL
3	PLUG			
4	CLUTCH	WHT	12	GXL
5	GROUND	BLK	18	GXL

GROUND Y379				
PIN CIR #	LABEL	COLOR	GA	TYPE
A	CHASSIS GRD	BLK	12	GXL

BAT POWER Y380				
PIN CIR #	LABEL	COLOR	GA	TYPE
A	BATTERY	RED	12	GXL

FUSE Y816				
PIN CIR #	LABEL	COLOR	GA	TYPE
A	BATTERY	RED	12	GXL
B	BATTERY	RED	12	SXL

FOOT SWITCH Y721				
PIN CIR #	LABEL	COLOR	GA	TYPE
A	GROUND	BLK	18	TXL
B	AUX SWITCH	DK GRN	18	TXL
C	12VENABLE	ORG	18	TXL

TDR MODULE Y160				
PIN CIR #	LABEL	COLOR	GA	TYPE
1	GROUND	BLK	17	TXL
2	12VENABLE	ORG	18	TXL
3	AUX SWITCH	DK GRN	18	TXL
4	KEYED 12V	LI GRN	18	TXL
5	PLUG			
6	PLUG			
7	PLUG			
8	12VENABLE	ORG	18	TXL

CLUTCH Y897				
PIN CIR #	LABEL	COLOR	GA	TYPE
A	CLUTCH	WHT	12	SXL
B	CLUTCH	WHT	12	GXL
C	12VENABLE	ORG	18	TXL

ID LABEL	
OWNER	HEADSIGHT, INC
ITEM	SEE SHEET PART NUMBER
REVISION	SEE SHEET REV. #
DATE	BUILD DATE
MFG	SUPPLIER NAME

COMPONENT DATA									
ITEM	PART ID	QTY	DESCRIPTION	MFG	MFG PN	TERMINAL PN	ACCESSORY PN	ACCESSORY PN	ACCESSORY PN
1	Y379, Y380	2	TERM, RING, 0.375", UNINS	VARIOUS	TE: 61289-1	OR SIMILAR			
2	Y816	1	CONN, 2p MIP FEMALE BODY	DELPHI	15300027	12129493	15324981		15300014
3	Y816 CAP	1	CAP, MIP 2p F. B. FOR FUSE	WAYTEK	46058				
4	F1	1	FUSE, AUTO, MICRO-BLADE	VARIOUS	20 AMP, AUTO.				
5	Y160	1	C ONN, 8p PLUG	DEUTSCH	DT06-08SA	0462-201-16141	1011-244-0805	114017	W6S
6	Y721	1	C ONN, 3p PLUG	DEUTSCH	DT06-3S	0462-201-16141			W6S
7	Y897	1	CONN, 3p WP SHROUD	DELPHI	12010717	(2) 12124587*	(2) 15324981*		
8						(1) 12089040*	(1) 15324983*		
9									
10	RLY 1	1	CONN, ISO RELAY, SEALED	DELPHI	12092605	12066614*			
11						12033997*			
12	RELAY	1	SEALED RELAY, ISO, BRKT	OMRON	G8UN-1C6T-F-R-D C12	OR EQUIV.	MUST HAVE BRACKET		
13									
14									

NOTES:
LANKOTA CLUTCH ADAPTER

REVISIONS			
REV	DESCRIPTION	DATE	APPROVED
4	SEALED RELAYS, BAT POWER	12.2.16	JHK
5	TDR MODULE Y160	2.2.18	JHK

HEADSIGHT
HARVESTING SOLUTIONS

DRAWN 7/31/2018
DRAWN BY: JHK

FILE NAME
HT9260-CAB R5 CLUTCH
CABLE LAYOUT

PART NUMBER
HT9260-CAB

SCALE NOT TO SCALE

REV 5

SHEET 01

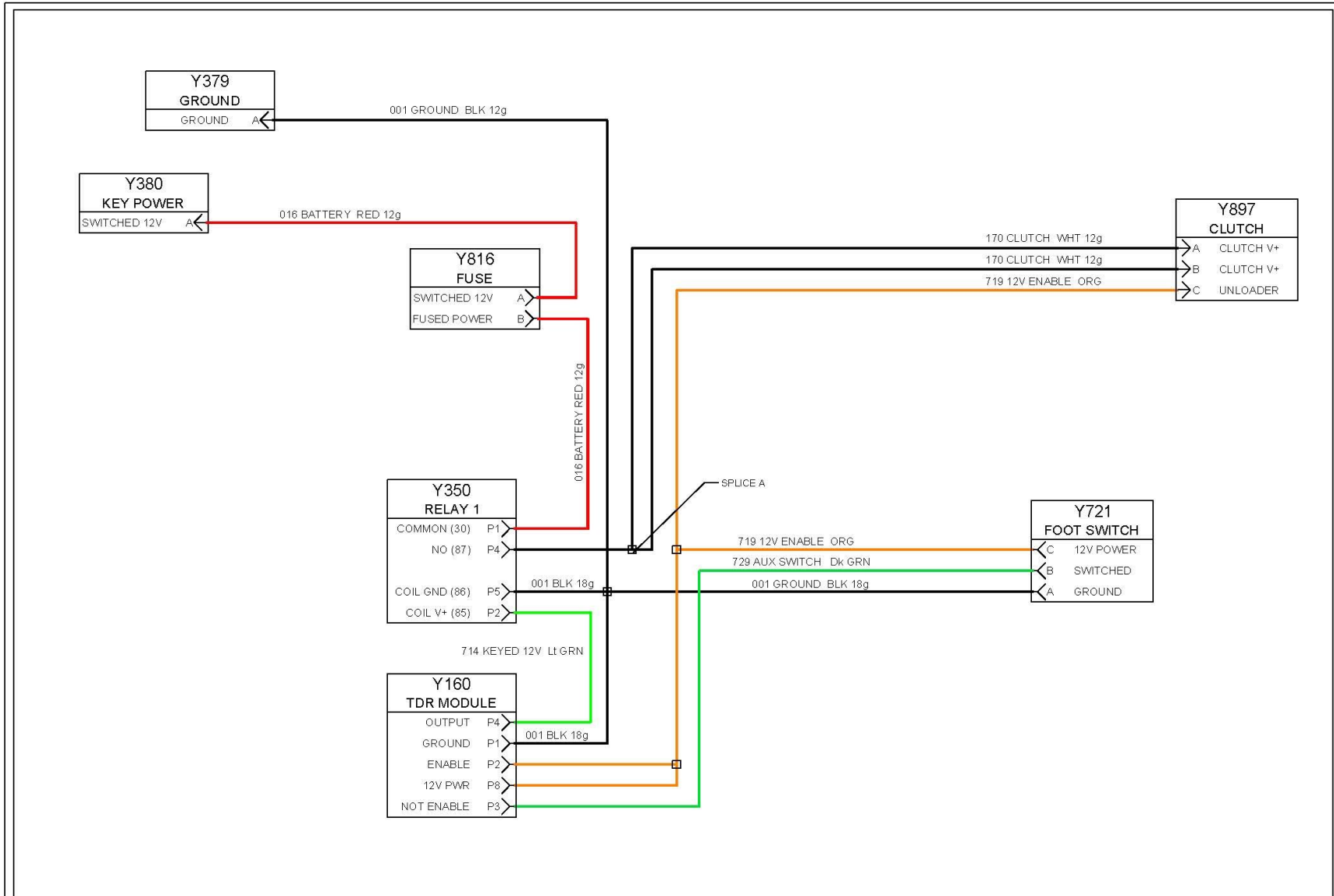

NOTES:
LANKOTA CLUTCH ADAPTER

REVISIONS			
REV	DESCRIPTION	DATE	APPROVED

HEADSIGHT
HARVESTING SOLUTIONS

DRAWN 7/31/2018
DRAWN BY: JHK

FILE NAME HT9260-CAB R5 CLUTCH WIRING SCHEMATIC	
PART NUMBER HT9260-CAB	REV 5
SCALE NOT TO SCALE	SHEET 02

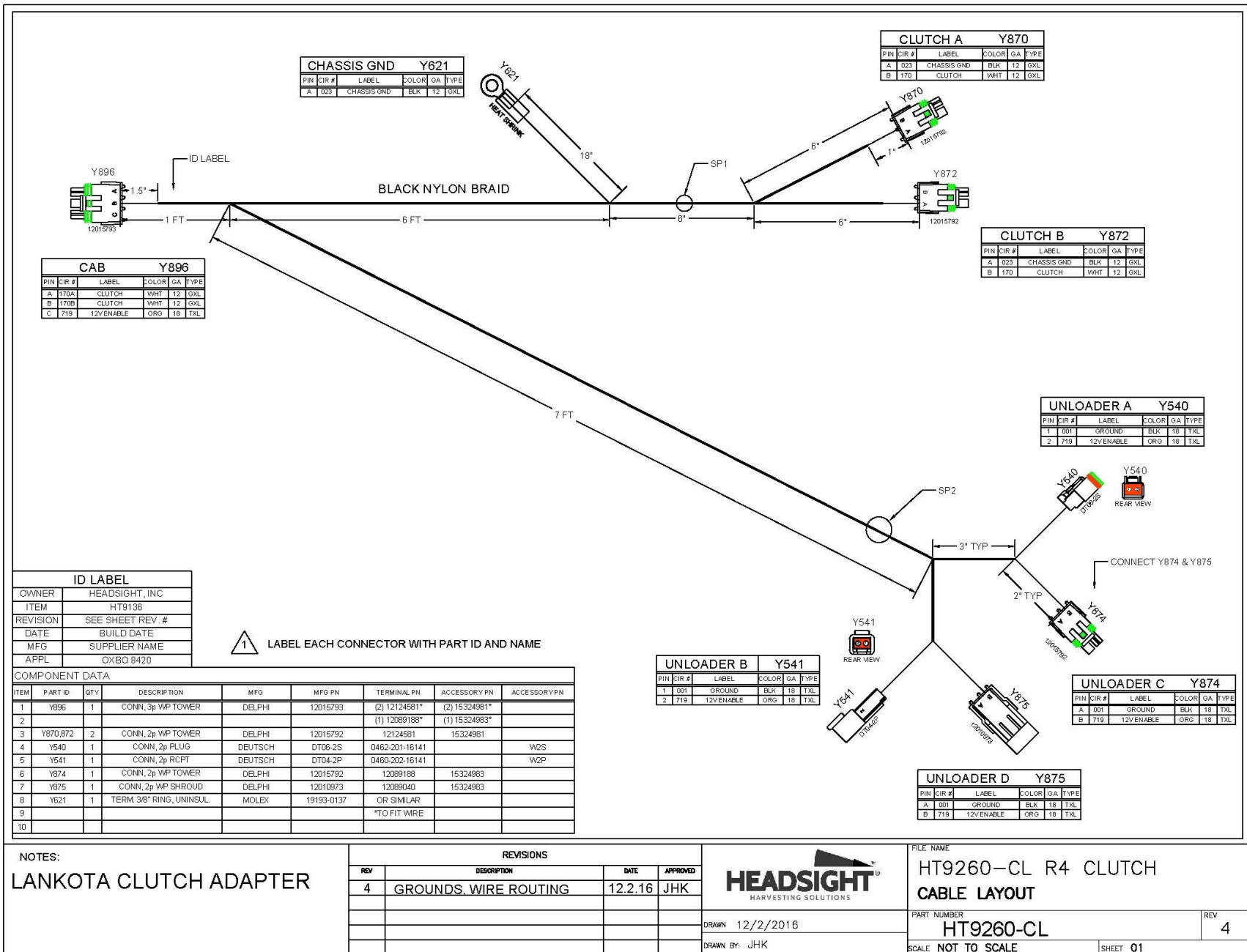

PIN	CIR #	LABEL	COLOR	GA	TYPE
A	170A	CLUTCH	WHT	12	GXL
B	170B	CLUTCH	WHT	12	GXL
C	719	12V ENABLE	ORG	18	TXL

PIN	CIR #	LABEL	COLOR	GA	TYPE
A	023	CHASSIS GND	BLK	12	GXL

PIN	CIR #	LABEL	COLOR	GA	TYPE
A	023	CHASSIS GND	BLK	12	GXL
B	170	CLUTCH	WHT	12	GXL

PIN	CIR #	LABEL	COLOR	GA	TYPE
A	023	CHASSIS GND	BLK	12	GXL
B	170	CLUTCH	WHT	12	GXL

PIN	CIR #	LABEL	COLOR	GA	TYPE
1	001	GROUND	BLK	18	TXL
2	719	12V ENABLE	ORG	18	TXL

PIN	CIR #	LABEL	COLOR	GA	TYPE
1	001	GROUND	BLK	18	TXL
2	719	12V ENABLE	ORG	18	TXL

PIN	CIR #	LABEL	COLOR	GA	TYPE
A	001	GROUND	BLK	18	TXL
B	719	12V ENABLE	ORG	18	TXL

PIN	CIR #	LABEL	COLOR	GA	TYPE
A	001	GROUND	BLK	18	TXL
B	719	12V ENABLE	ORG	18	TXL

OWNER	HEADSIGHT, INC
ITEM	HT9136
REVISION	SEE SHEET REV. #
DATE	BUILD DATE
MFG	SUPPLIER NAME
APPL	OXBO 8420

1 LABEL EACH CONNECTOR WITH PART ID AND NAME

ITEM	PART ID	QTY	DESCRIPTION	MFG	MFG PN	TERMINAL PN	ACCESSORY PN	ACCESSORY PN
1	Y896	1	CONN, 3p WP TOWER	DELPHI	12015793	(2) 12124581*	(2) 15324981*	
2						(1) 12089188*	(1) 15324983*	
3	Y870,872	2	CONN, 2p WP TOWER	DELPHI	12015792	12124581	15324981	
4	Y540	1	CONN, 2p PLUS	DEUTSCH	DT06-2S	0462-201-16141		W2S
5	Y541	1	CONN, 2p RCPT	DEUTSCH	DT04-2P	0460-202-16141		W2P
6	Y874	1	CONN, 2p WP TOWER	DELPHI	12015792	12089188	15324983	
7	Y875	1	CONN, 2p WP SHROUD	DELPHI	12010973	12089040	15324983	
8	Y621	1	TERM 3/8" RING, UNINSUL	MOLEX	19193-0137	OR SIMLAR		
9						*TO FIT WIRE		

NOTES:
LANKOTA CLUTCH ADAPTER

REV	DESCRIPTION	DATE	APPROVED
4	GROUND. WIRE ROUTING	12.2.16	JHK

HEADSIGHT
HARVESTING SOLUTIONS

DRAWN 12/2/2016
DRAWN BY: JHK

FILE NAME	HT9260-CL R4 CLUTCH CABLE LAYOUT	
PART NUMBER	HT9260-CL	REV 4
SCALE	NOT TO SCALE	SHEET 01

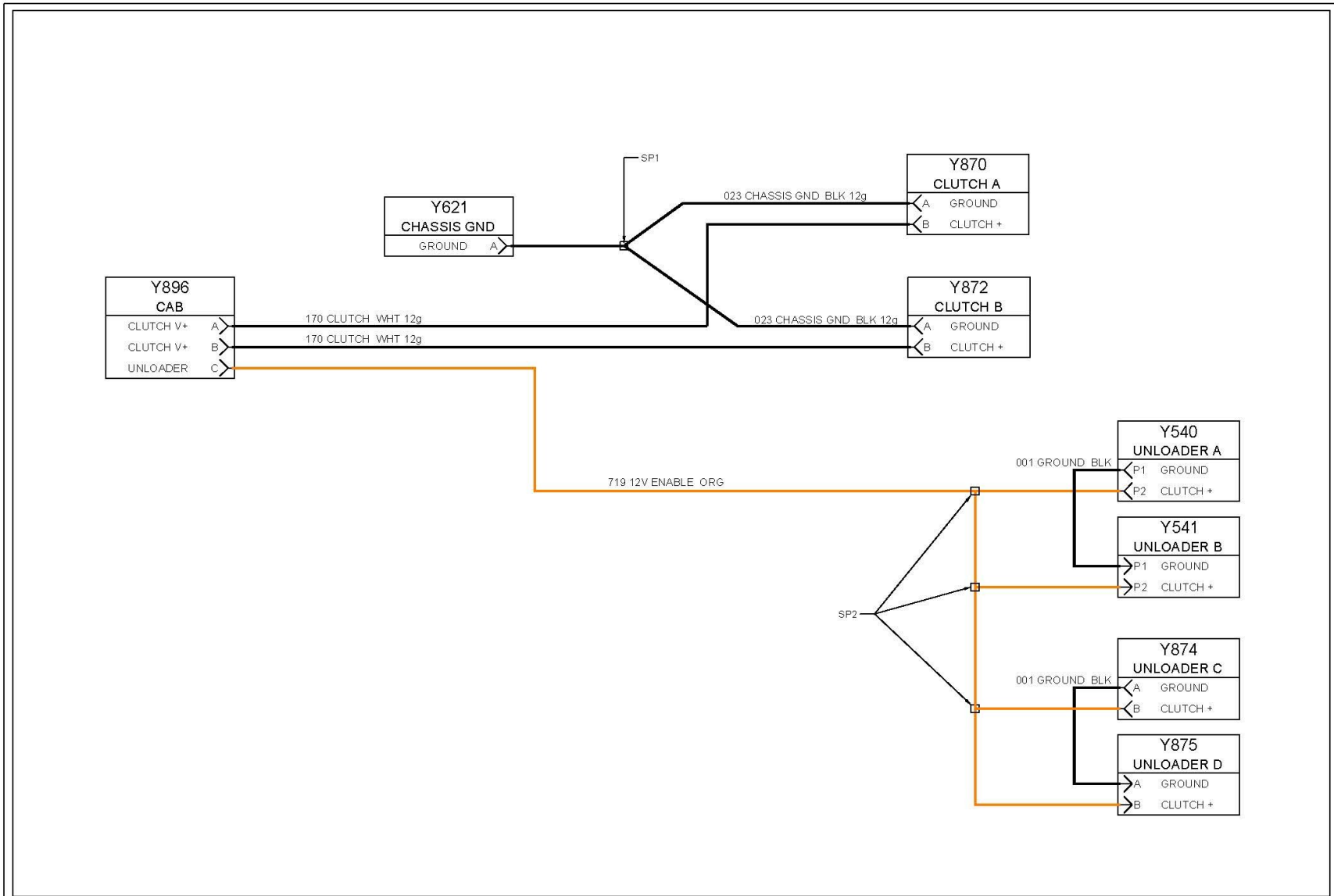

NOTES: LANKOTA CLUTCH ADAPTER	REVISIONS					FILE NAME HT9260-CL R4 CLUTCH WIRING SCHEMATIC	
	REV	DESCRIPTION	DATE	APPROVED		PART NUMBER HT9260-CL	REV 4
					DRAWN 12/2/2016		
					DRAWN BY: JHK	SCALE NOT TO SCALE	SHEET 02



HT9218 MODULE

DIAGNOSTICS ASSIST

09062027a

Description

The HT9218 TDR Module is used with the Lankota "Cross Auger Clutch Kit". It operates as both a logic module and a Delay Timer to allow the main auger to start first, then engage the cross augers.

Functionality

The module operates on 12V DC, has 2 inputs, and a single output.

- Pin 1 = Ground
- Pin 6 = +12V power supply
- CNH - Keyed 12V
- JD - Unloader clutch 12V (same as pin 3)
- Pin 3 is the Enable input from the OEM unloader clutch
- V > 9V or 25% PWM, Enable output (with time delay)
- Pin 2 is the Disable input from the foot switch
- V > 9V or 25% PWM, Turn OFF output
- Pin 4 is the Output pin, used to turn on the cross-auger clutch relay

Indicators

The unit has 3 LED indicators to assist Troubleshooting:

- GREEN - Power: nominal +12V supply to unit
- YELLOW - Enable is Active (OEM Unloader Clutch > 9V or 25% PWM)
- RED - Output is ON

Correct Operation

1. When the OEM unloading auger is NOT running:
 - JD - No LED's are on
 - CNH - Only Green LED is ON (whenever the combine key is on)
2. Green & Yellow LEDs both ON whenever the OEM unloading auger clutch is engaged.
3. Red LED turns ON after Time delay (4-6 seconds), relay closes, cross auger clutches engage.
4. Pressing the foot switch immediately stops augers, releasing foot switch immediately starts augers.



LED Diagnostics

The following requirements must be met before testing:

- Key on, combine engine running . Unloader running

Step thru the chart by Light Function

- STEP 1 - Is the Green Light working properly?
- STEP 2 - Is the Yellow Light working properly?
- STEP 3 - Is the Red Light working properly?

Measure voltages, etc in 6 pin plug that connects to module, not on actual module pins.

Error Code	Problem	Solution
No Green Light OE Unloader running	No Ground - Test Continuity. Pin 1 in plug to Frame Ground	Repair wire or find better ground bolt
	No 12V. CNH - Measure Pin 6 in plug to Frame Ground	Check 12V supply in cab, or wiring
	No 12V, JD - Measure Pin 6 in plug to Frame Ground	See No Yellow Light, OEM Unloader running
	12V, Pin 6 to Pin 1 in plug	Replace Module
No Yellow Light OEM Unloader Running	No Voltage - Not connected to Unloader Clutch plug,	Find correct plug (see Install Manual)
	No Voltage - Orange wire broken. Test continuity from Pin 3 in plug to orange wire in any of the Unloader Clutch Tee plugs	Repair wire Check 3 Pin WP connection Y896/Y897
	JD - Y540/Y541, Y874, Y875 CNH - C249, X449	
	No Ground - Test Continuity. Pin 1 in plug to Frame Ground	Repair wire or find better ground bolt
No RED Light OEM Unloader running, Time Delay > 6 seconds after starting Unloader	Voltage as shown, Pin 3 to Pin 1 in plug	Replace Module
	No Ground - Test Continuity. Pin 1 in plug to Frame Ground	Repair wire or find better ground bolt
	Foot Switch ON Disconnect foot switch plug Y721	Test foot switch or wiring
	Defective module	Replace Module
All Lights ON, Cross Augers not energized (No 12V A-B in clutch plugs)	No Battery Power Measure large Red Wire at relay	Connect Red wire, Check Fuse, repair wire
	Defective Power Relay	Replace Relay
	Clutches not Grounded	Check Ground bolt connection in clutch harness

Finishing Up

1. Make one final check to complete wiring harness to ensure there are no points in the harness that will come in contact with anything that may damage the harness during combine operation and/or L/H main access door opening and closing.
2. Do a final check of all nuts, bolts etc. installed to make sure they are all tight and secure.

Test Run

Test run the system. The unloading auger system should work exactly the same as it did before you installed this kit except when the foot switch is engaged the two grain tank cross augers will stop turning allowing the unloading auger to empty out roughly 85 - 90%. As soon as pressure is released from the foot switch, the augers will reengage. This means that anytime you want the cross augers not to turn, you must have your foot on the foot switch.

The initial burnish process of the clutches contained in this kit has been performed by Lankota prior to shipment. Seasonal reburnishing of the clutches at the beginning of every harvest season will greatly increase the life of your clutch system.

To burnish the clutches:

1. Swing out the auger.
2. Start the unloading auger.
3. Run combine on high idle.
4. Press and release the foot switch 5-10 times.

**THESE TIPS NEED TO REMAIN IN THE COMBINE
WITH THE OPERATOR AT ALL TIMES**

**TIPS TO ENSURE LONG LIFE OF YOUR LANKOTA
GRAIN TANK CROSS AUGER CLUTCH SHUT OFF SYSTEM**

WIRING SYSTEM NEEDS GROUNDED TO THE BATTERY:

(John Deere® Kits Only) Most kits have been installed with the grounding wire attached to a bolt usually above the battery box. Even though there might be factory wiring grounded to this bolt, it is **NOT** a sufficient ground for the clutch kit. **For Pre “S” Series Combines**, remove the battery box lid and attach the ground wire to the **SWITCHED** side of the battery cut off switch. Do not connect to the side of the switch that is directly connected to the **BATTERY** ground, that will drain your battery. **On “S” Series Combines**, attach ground wire directly to the battery.

BURNISH CLUTCHES REGULARLY:

If you have not used the unloading auger clutch system for several days, such as at the beginning of every season, or after a weather delay, make sure to run the engine at high RPM, engage the unloading auger system with an empty grain tank and slowly cycle the foot pedal on and off 15 – 20 times to clean the surfaces of the clutch. This will rid the mating surfaces of rust and dirt which can cause the clutch to slip.

GRAIN TANK CROSS AUGER COVERS:

For high moisture crops (corn especially), put the grain tank cross auger covers in the **DOWN** position on the far **RIGHT** side of the grain tank. Put them in the **UP** position on the auger side or left side of the grain tank. This will minimize compacting the wet corn under the auger covers.

MAKE SURE GRAIN TANK SUMP IS CLEAN:

Even if you put your combine in a shed **EVERY NIGHT**, there still will be dirt and build up in your grain tank sump. As a rule of thumb, with a clutch kit installed or not, you should drain and clean out the sump **WEEKLY**, even if there is not wet material present. Cleaning out the sump will guarantee you do not have any clumps of rotten grain, hard dirt or ice hindering the flow of grain.

NEVER LEAVE WET GRAIN IN THE GRAIN TANK:

Never leave high moisture grain in the grain tank for long periods of time. This will settle and act like cement causing many problems.

For any questions, comments or concerns, please contact Lankota @ 866 – 526 – 5682. We are happy to help you have the best harvesting experience possible. After hours and weekend emergency tech support available by calling the above phone number.