

# **LANSSDR830R4GT**

## **Installation Instructions**

**Lankota GENERATION II Stalk Stomper® Kit for Drago® 830 GT Series Corn Head - 4 Row Coverage**





# **LANKOTA®**

**270 West Park Avenue  
Huron, SD 57350  
866-526-5682**

# Numerical Parts List

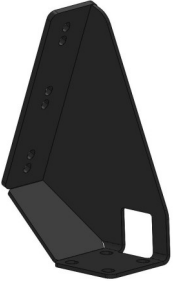
<b>Part Numbers</b>	<b>Description</b>	<b>Quantity</b>
LANSSDRGT101	Drago GT Stalk Stomper Mount	1
LANSSDRGT102	Drago GT Stalk Stomper Mount	1
LANSSDRGT103	Drago GT Stalk Stomper Mount	1
LANSSDRGT104	Drago GT Stalk Stomper Mount	1
LANSSDRGT106	PTO Holder	2
LANSS659	Straight Flip Up Mount	4
LANSSB77BLK	77" Stomper Bar, Black	2
<b>LANSSDR830R4GTBH</b>	<b>Box of Hardware</b>	<b>1</b>
LAN600UBOLT	U-bolt 5/8" x 2.265" ID x 3.75" Length	8
LAN690830	5/8"-11 Serrated Flange Nut	16
LANFG36R	M12 x 30 CLS8.8 Hex Flange Bolt	22
<b>LANSS668BH</b>	<b>Bag of Hardware for SS668</b>	<b>4</b>
LAN600UBOLT	U-bolt 5/8" x 2.265" ID x 3.75" Length	2
LAN690830	5/8"-11 Serrated Flange Nut	4
LANFNXC1	1/2"-13 Flanged Nyloc Nut	1
LANFNHVK	1/2"-13 x 2.5" Flanged Cap Screw	1

# Pictorial Parts List

			
LANSSDRGT101 (1)	LANSSDRGT102 (1)	LANSSDRGT103 (1)	LANSSDRGT104 (1)
			
LANFG36R (22)	LANSS659 (4)	LANSSB77BLK (2)	LANSSDRGT106 (2)
			
LAN600UBOLT (16)	LAN690830 (32)	LANFNHVK (8)	LANFNXC1 (8)

# Preparation

1. Attach desired header to the combine. Lock the head to the combine.
2. Raise the head off the ground and lower the safety stop on the feeder house cylinder.
3. Set the parking brake on the combine.
4. Turn off the combine engine and remove the key.

## 1. Install Brackets & Bars

Refer to Figures 1.1 & 1.2

- 1.1 Remove the two bolts on each end of the head that are shown.
- 1.2 Remove the PTO Holder from both sides of the head.

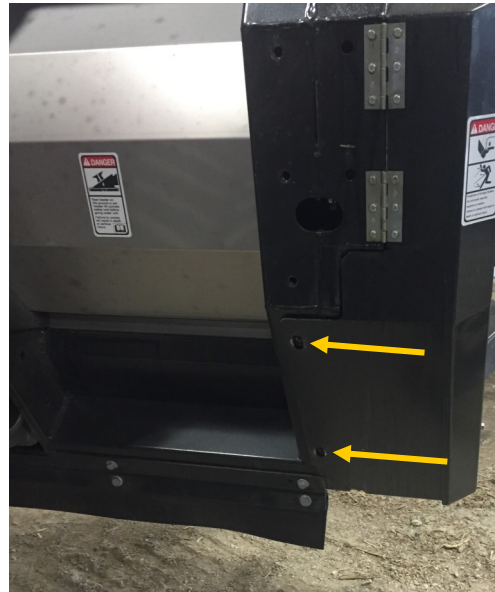

Figure 1.1

Figure 1.2



# 1. Install Brackets & Bars

## Refer to Figure 1.3

**1.3** Install mount LANSSDRGT101 on the right side of the head and LANSSDRGT102 on the left side using two M12 flange bolts (LANFG36R) each. Use the holes exposed in the earlier step. Tighten.

## Refer to Figure 1.4

**1.4** Install mount LANSSDRGT103 on the right side of the feederhouse and LANSSDRGT104 on the left side using six M12 x 30mm flange bolts (LANFG36R) each. Tighten.

**Note:** There are two sets of holes to choose from. As a guideline, the top holes should be used when the head will be running at the steepest angle and/or be carried away from the ground more than 6 inches. Otherwise, use the bottom holes.



Figure 1.3



Figure 1.4

**NOTE:** The brackets in the kit will not have this gusset



# 1. Install Brackets & Bars

## Refer to Figure 1.5

**1.5** Install the PTO Hooks (LANSSDRGT106) on both sides of the feederhouse with two M12 flange bolts in the outer set of holes as shown. Tighten and set the PTO shafts into the hooks.

## Refer to Figure 1.6 & 1.7

**1.6** Install a 77" toolbar on each side of the head using two U-bolts and four 5/8" serrated flange nuts at each bracket as shown.

**1.7** Slide the bar inwards until the outer end is almost flush with the outer bracket and tighten. The bar will jut in towards the feederhouse.



Figure 1.6

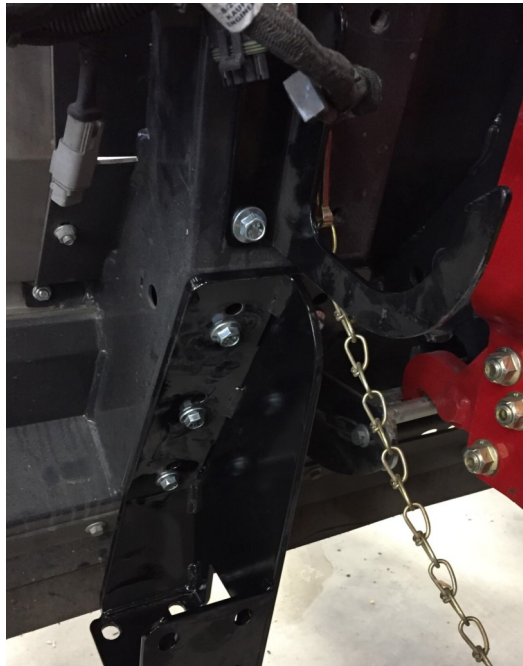

Figure 1.5

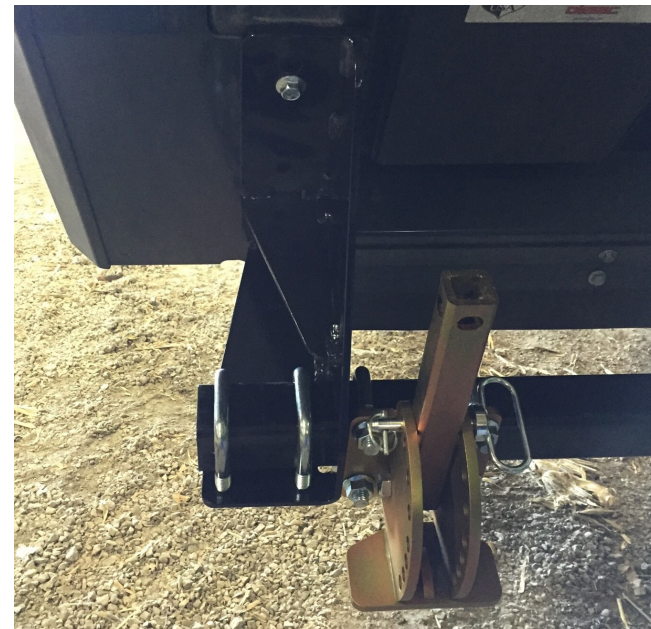

Figure 1.7

## 2. Install Shoes & Mounts

Refer to Figure 2.1 & 2.2

- 2.1 Install four LANS659 flip-up mounts on the appropriate rows. Each mount should sit directly behind a row and mount on the backside of the bar with two U-bolts and four nuts.



Figure 2.1

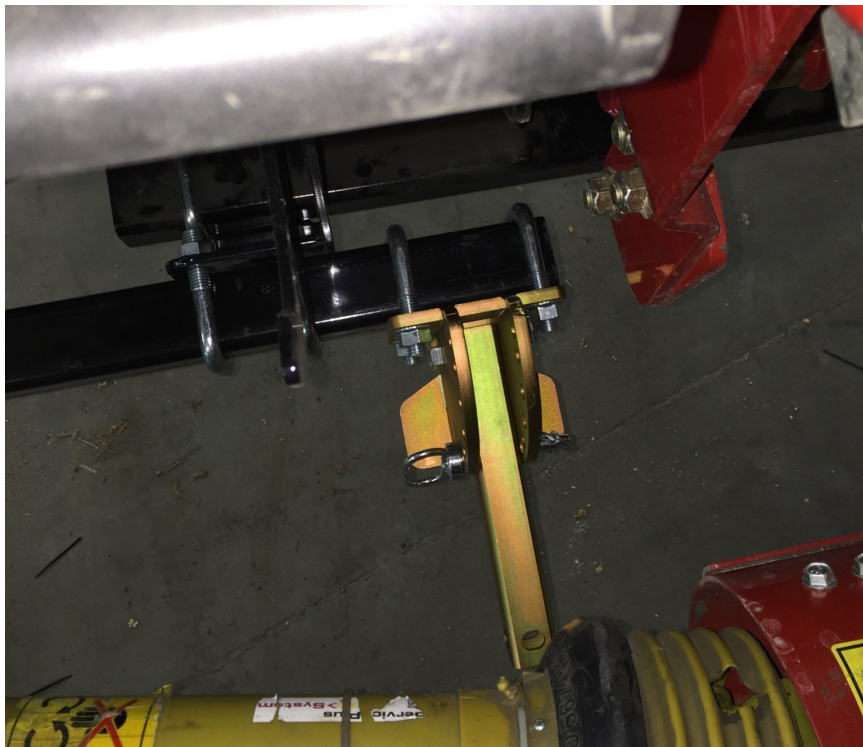

Figure 2.2



## 2. Install Shoes & Mounts

Refer to Figure 2.3

2.2 Slide the shoes onto the flip-up mounts and attach using the 1/2" flanged bolts and nuts.

Figure 2.3

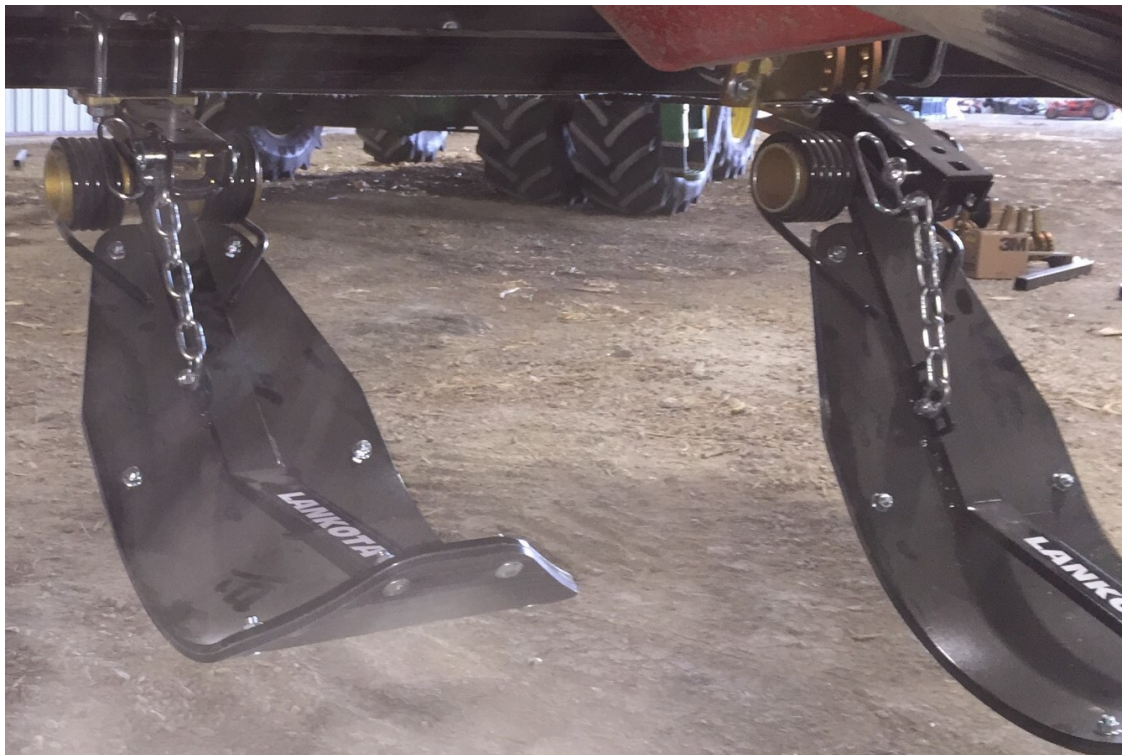



# Stalk Stomper Disclaimer

## *Stalk Stomper Disclaimer*

The most effective use of the Lankota Stalk Stomper® is achieved by adjusting the stomper pad so that when the corn head is at its normal cutting height, the pad of the shoe is 1" above the ground. Over compression of the spring can shorten the life of the stomper spring, increase wear on the poly liner, and may result in undue damage NOT covered by Lankota's Limited Warranty.

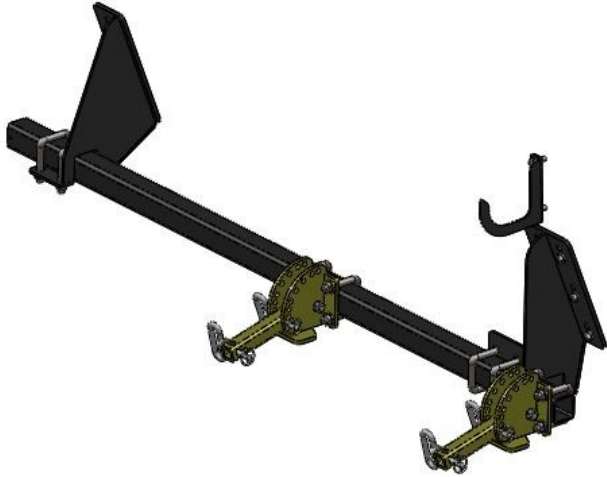

For further technical assistance,  
call Lankota Inc. at:  
1-866-526-5682

