

LANSSDR1230R4

Installation Instructions

Lankota GENERATION II Stalk Stomper® Mounting Kit for DRAGO® 1230 Series Corn Heads

4-Row Coverage

LANKOTA®

270 West Park Avenue

Huron, SD 57350

866-526-5682













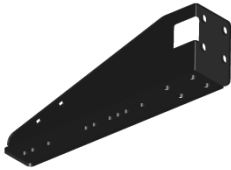



Numerical Parts List

Part Numbers	Description	Quantity
LANSSDRAGO110L	Drago Toolbar Mount, Left	1
LANSSDRAGO110R	Drago Toolbar Mount, Right	1
LANSSDRAGO200L	Drago Outer Toolbar Mount, Left	1
LANSSDRAGO200R	Drago Outer Toolbar Mount, Right	1
LANSSDRAGO102	Nut Plate for Mount Brackets	4
LANSSDRAGO103	Driveline Storage Hook	2
LANSSB67BLK	67" Toolbar	2
LANSS659	Flip up stomper mount	4
LANSSDR1230R4BH	Box Containing Hardware	1
LAN600UBOLT	U-bolt - 5/8" x 3.75"L x 2.625"W	8
LAN690830	5/8" Serrated Flange Nut	16
LAN26B00	5/8" x 2" Bolt	12
REDWL57	5/8" Lock Washer	12
LAN506K	1/2" x 1.5" Carriage Bolt	4
LAN3722	1/2" Flange Nut	4

Numerical Parts List Continued

Part Numbers	Description	Quantity
LANSS668BH	LANSS668 Bag of Hardware	4
Each Bag Includes:		
LAN600UBOLT	U-bolt - 5/8" x 3.75" L x 2.625" W	2
LAN690830	5/8" Serrated Flange Nut	4
LANFNHVK	1/2"-13 x 2.5" Flanged Cap Screw	1
LANFNXC1	1/2"-13 Flanged Nyloc Nut	1
Optional Part List		
LANSS601A-POLY	Poly skid shoe	12
LANSS601A-POLYBH	8 carriage bolts and flange nuts per bag	12

Pictorial Parts List

			
LANSSDRAGO110L (1)	LANSSDRAGO110R (1)	LANSSDRAGO200L (1)	LANSSDRAGO200R (1)
			
LANSS659 (4)	LANSSDRAGO103 (2)	LANSSB67BLK (2)	LANSSDRAGO102 (4)
			
LAN26B00 (12)	LAN600UBOLT (16)	LAN690830 (32)	REDWL57 (12)
			
LAN506K (4)	LAN3722 (4)	LANFNXC1 (4)	LANFNHVK (4)

Optional Pictorial Parts List



LANS601A-POLY



3/8" x 1" Carriage Bolt
(8 per shoe)



3/8" Flange Lock Nut
(8 per shoe)

Stalk Stomper Disclaimer

Stalk Stomper Disclaimer

The most effective use of the Lankota Stalk Stomper® is achieved by adjusting the stomper pad so that when the corn head is at its normal cutting height, the pad of the shoe is 1" above the ground. Over compression of the spring can shorten the life of the stomper spring and may result in undue damage NOT covered by Lankota's Limited Warranty.

Preparation

1. **Attach desired header to the combine. Lock the head to the combine.**
2. **Raise the head off the ground and lower the safety stop on the feeder house cylinder.**
3. **Set the parking brake on the combine.**
4. **Turn off the combine engine and remove the key.**

1. Installation

Refer to Figure 1.1

- 1.1. Remove the driveline storage hooks from both sides of the feeder house.**
- 1.2. Drill out the holes indicated using a 5/8" drill bit.**

Refer to Figure 1.2

- 1.3. Mount the LANSSDRAGO110L & LANSSDRAGO110R brackets to the head on each side of the feeder house opening as shown. Use nut plate (LANSSDRAGO103), 5/8" x 2" Bolt, and lock washer.**

Hardware:

LAN26B00	5/8" x 2.0" Hex Bolt
REDWL57	5/8" Lock Washer

Note: The bolt hole pattern on these brackets matches most heads on the market. On some heads a 5/8" hole will need to be drilled at the top location, using the bracket as a template.

Refer to Figure 1.3

- 1.4. Install new driveline storage hooks (LANSSDRAGO103) using 1/2" carriage bolts and 1/2" flange nuts.**

Hardware:

LAN506K	1/2" x 1.5" Carriage Bolt
LAN3722	1/2" Flange Nut

Figure 1.1



Figure 1.2



Refer to Figure 1.3

- 1.5. Mount the LANSSDRAGO200L & LANSSDRAGO200R brackets to the head on each side of the head as shown. Use nut plate (LANSSDRAGO103), 5/8" x 2" Bolt, and lock washer.**

Hardware:

LAN26B00	5/8" x 2.0" Hex Bolt
REDWL57	5/8" Lock Washer

- 1.6. Install a 67" toolbar on both sides of the feederhouse.**

Hardware:

LAN600UBOLT	U-bolt 5/8" x 2.5"
LAN690830	5/8" Flange Nut

- 1.7. Mount two LANSS659 flip up mounts to each 67" toolbar as shown, align with each row.**

Hardware:

LAN600UBOLT	U-bolt 5/8" x 2.5"
LAN690830	5/8" Flange Nut



Figure 1.3

Optional Stalk Stomper® Poly Installation

Refer to Figure 1.4

Note: If you did not order the optional poly please skip this step.

1.8. Attach poly wear plates to bottom of the Lankota Stalk Stomper® shoe utilizing 8 bolts and 8 nuts provided in the LANSS601A-POLYBH bag of hardware.

Figure 1.4



Refer to Figure 1.12

- 1.9. Slide the Lankota Stalk Stomper® (LANSS651) onto and bolt the Stalk Stomper® shoe (LANSS651) to the flip up mount (LANSS659) using 1 flanged bolt (LANFNHVK) and 1 nyloc nut (LANFNXC1) found in the bags of hardware marked (LANSS668BH). Tighten and secure. Use the flip up option of the flip up mounts (LANSS65) to clear tires on trailers.

Figure 1.12

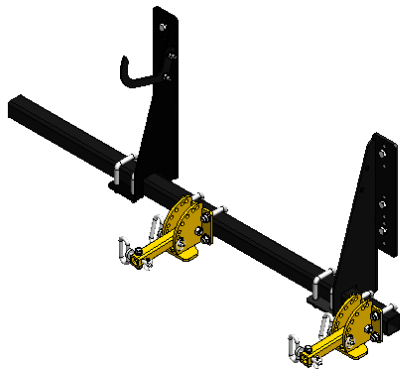

For further technical assistance,

call Lankota at:

1-866-526-5682

