

LANSSDR1230R2GTF

Installation Instructions

Lankota GENERATION II Stalk Stomper® Kit for Drago® 1230 GT Series Folding Corn Head - 2 Row Coverage



LANKOTA®

**270 West Park Avenue
Huron, SD 57350
866-526-5682**

Numerical Parts List

Part Numbers	Description	Quantity
LANSSDRGT101	Drago GT Stalk Stomper Mount	1
LANSSDRGT102	Drago GT Stalk Stomper Mount	1
LANSSDRGT103	Drago GT Stalk Stomper Mount	1
LANSSDRGT104	Drago GT Stalk Stomper Mount	1
LANSSDRGT106	PTO Holder	2
LANSS759	Straight Flip Up Mount	2
LANSSB42BLK	42" Stomper Bar, Black	2
LANSSDR1230R4GTFBH	Box of Hardware	1
LAN600UBOLT	U-bolt 5/8" x 2.265" ID x 3.75" Length	8
LAN690830	5/8"-11 Serrated Flange Nut	16
LANFG36R	M12 x 30 CLS8.8 Hex Flange Bolt	22
LANSS668BH	Bag of Hardware for SS668	2
LAN600UBOLT	U-bolt 5/8" x 2.265" ID x 3.75" Length	2
LAN690830	5/8"-11 Serrated Flange Nut	4
LANFNXC1	1/2"-13 Flanged Nyloc Nut	1
LANFNHVK	1/2"-13 x 2.5" Flanged Cap Screw	1

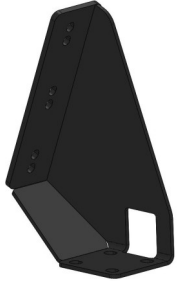
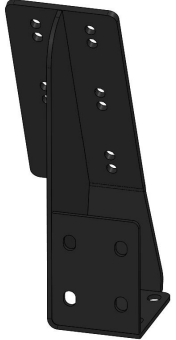
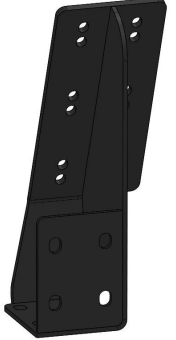
Pictorial Parts List

			
LANSSDRGT101 (1)	LANSSDRGT102 (1)	LANSSDRGT103 (1)	LANSSDRGT104 (1)
			
LANSSDRGT106 (2)	LANSS759 (2)	LANSSB42BLK (2)	LANFG36R (22)
			
LAN600UBOLT (12)	LAN690830 (24)	LANFNXC1 (2)	LANFNHVK (2)

Preparation

1. Attach desired header to the combine. Lock the head to the combine.
2. Raise the head off the ground and lower the safety stop on the feeder house cylinder.
3. Set the parking brake on the combine.
4. Turn off the combine engine and remove the key.

1. Install Brackets & Bars

Refer to Figures 1.1

- 1.1 Remove the PTO Holder from both sides of the head.

Figure 1.1



1. Install Brackets & Bars

Refer to Figure 1.2

1.2 Install mount LANSSDRGT101 on the right side of the head and LANSSDRGT102 on the left side using three M12 flange bolts (LANFG36R) each. The mount goes on the central section of the head, just inside of the gearbox. Tighten.

Refer to Figure 1.3

1.3 Install mount LANSSDRGT103 on the right side of the feederhouse and LANSSDRGT104 on the left side using six M12 x 30mm flange bolts (LANFG36R) each. Tighten.

Note: There are two sets of holes to choose from. As a guideline, the top holes should be used when the head will be running at the steepest angle and/or be carried away from the ground more than 6 inches.



Figure 1.2



Figure 1.3

1. Install Brackets & Bars

Refer to Figure 1.4

1.4 Install the PTO Hooks (LANSSDRGT106) on both sides of the feederhouse with two M12 flange bolts in the outer set of holes as shown. Tighten and set the PTO shafts into the hooks.

Refer to Figure 1.5 & 1.6

1.5 Install a 42" toolbar on each side of the feederhouse using two U-bolts and four 5/8" serrated flange nuts per bracket.



Figure 1.5

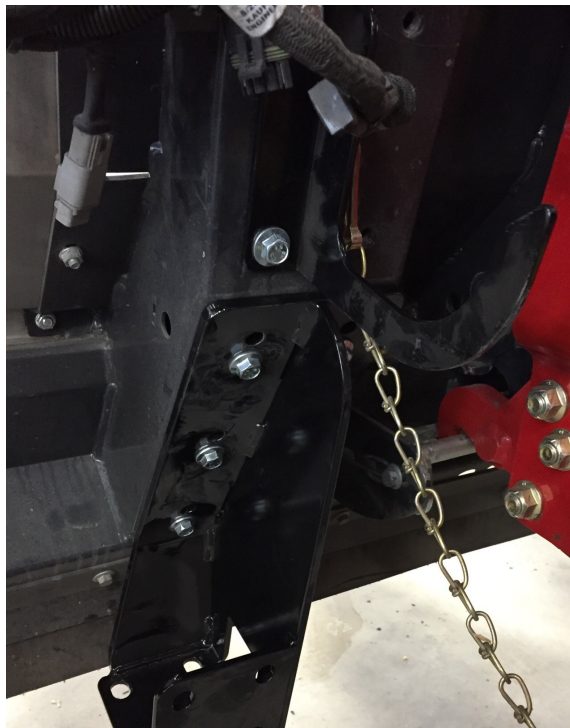

Figure 1.4



Figure 1.6

2. Install Shoes & Mounts

Refer to Figure 2.1 & 2.2

2.1 Install one LANS759 flip-up mount on the intended row next to the feederhouse on both sides of the head. Each mount sits directly behind a row and mounts on the backside of the bar with two U-bolts and four nuts.



Figure 2.1

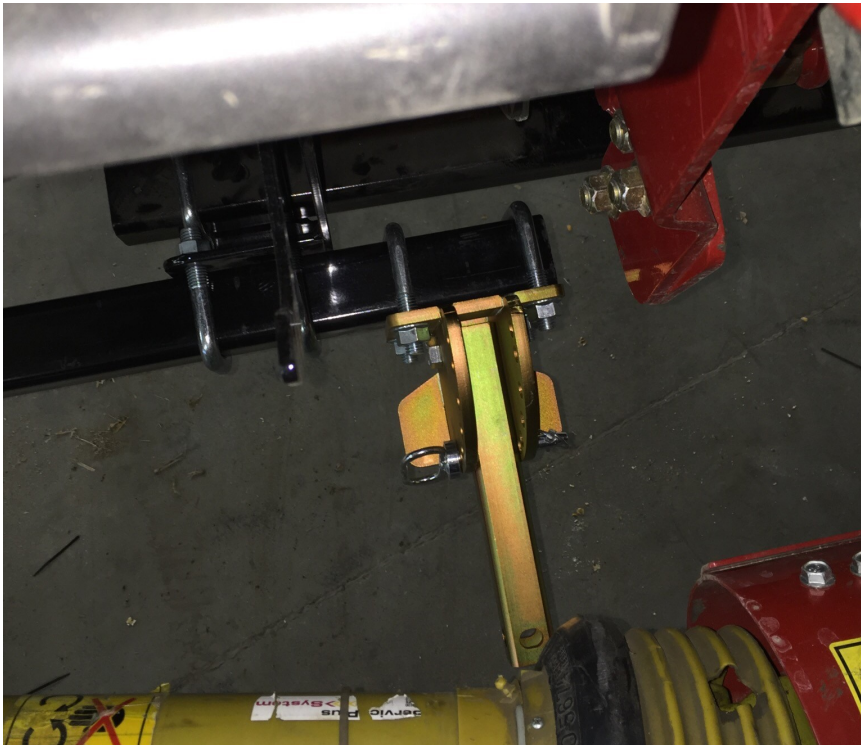

Figure 2.2

2. Install Shoes & Mounts

Refer to **Figure 2.3**

2.2 Attach the two shoes to the flip-up mounts using the 1/2" Flanged bolts and nuts.

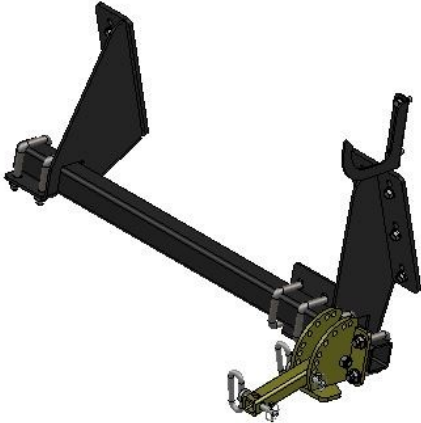

Figure 2.3

Stalk Stomper Disclaimer

Stalk Stomper Disclaimer

The most effective use of the Lankota Stalk Stomper® is achieved by adjusting the stomper pad so that when the corn head is at its normal cutting height, the pad of the shoe is 1" above the ground. Over compression of the spring can shorten the life of the stomper spring, increase wear on the poly liner, and may result in undue damage NOT covered by Lankota's Limited Warranty.



For further technical assistance,

call Lankota Inc. at:

1-866-526-5682

