

LANSRJD8000

Installation Instructions

Lankota Stalk Roller Kit for JD® 8X2X, 8X3X, AND 8XXXR Series Tractors

LANKOTA®

**270 West Park Avenue
Huron, SD 57350
866-526-5682**











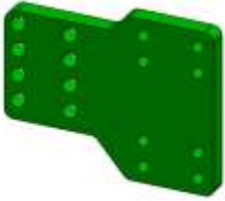









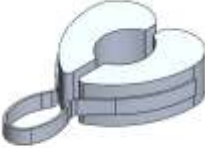

Numerical Parts List

| Part Numbers | Description | Qty |
|--------------------|--|----------|
| LANSR003 | FWA Stalk Roller Assembly | 2 |
| LANSR005 | FWA Stalk Roller Mount Frame | 1 |
| LANSR006 | FWA Stalk Roller Wing Frame | 1 |
| LANSR007 | FWA Stalk Roller Wing Frame | 1 |
| LANSR008 | FWA Stalk Roller Wing Pin | 2 |
| LANSR009 | FWA Stalk Roller Plastic Washer | 4 |
| LANSR010 | FWA Stalk Roller Frame Spacer | 2 |
| LANSR014 | FWA Stalk Roller JD8000 Spacer Plate | 4 |
| LANSR015 | FWA Stalk Roller Mount for 20/30 Series Tractors | 2 |
| LANW250100-S | Hydraulic Cylinder for Stalk Rollers | 2 |
| LANSR012 | FWA Hydraulic Hose Bolt (20mm thread) | 2 |
| LANSR013 | FWA Hydraulic Hose Bolt (16mm thread) | 1 |
| LANSS704 | Stalk Stomper Pin Assembly - Bent Pin | 2 |
| LANSCA-1 | 1" Cylinder Stroke Control | 4 |
| LANSRJD8RHK | Hydraulic Hose kit for JD8R Stalk Rollers | 1 |
| ----- | 28" Hydraulic Hose - 3/8" | 2 |
| ----- | 40" Hydraulic Hose - 3/8" | 2 |
| ----- | 26 ft (312") Hydraulic Hose - 3/8" | 2 |
| ----- | 9/16" Male JIC to 9/16" Male ORB | 2 |
| ----- | 9/16" Male JIC Tee | 2 |
| ----- | 1/2" Female NPT Quick Coupler | 2 |
| ----- | 1/2" Female NPT to 1/2" Male NPT Tee | 2 |
| ----- | 1/2" NPT Male Coupling | 2 |
| ----- | 9/16" Male JIC to 1/2" Male NPT | 2 |
| ----- | 9/16" Male JIC to 9/16" Male ORB 90 Deg | 4 |







Numerical Parts List

| Part Numbers | Description | Qty |
|--------------------|--|----------|
| LANSRJD8RBH | Box of Hardware Includes: | 1 |
| LANFC507 | Hex Head Cap Screw - 1/2"-13 x 1.75", gr. 8 | 2 |
| RED1F30 | Top Lock Nut - 1/2"-13, gr. 5 | 2 |
| LAN20180 | Hex Head Cap Screw - M20-2.5 x 190mm, gr. 10.9 | 8 |
| LANFRCRF | Hex Head Cap Screw - M20-2.5 x 220mm, gr. 10.9 | 8 |
| LANFWS57 | SAE Flat Washer - 5/8" | 8 |
| REDB712 | Hex Head Cap Screw - 5/8"-11 x 3.00", gr. 5 | 8 |
| REDB710 | Hex Head Cap Screw - 5/8"-11 x 2.50", gr. 5 | 8 |
| LAN690830 | Serrated Flange Nut - 5/8"-11, gr. 5 | 24 |
| LAN079UBOLT | UBOLT - 5/8"-11 x 6.50" | 4 |
| LAN19M7800 | Flange Bolt - M8-1.5 x 50mm, gr. 10.9 | 1 |
| LAN112567 | Cover Plate | 3 |
| LAN120847 | Hydraulic Hose Holder Half | 6 |
| LANF3231 | Grease Zerk - 1/4"-28 | 4 |
| LANFMLW0 | Lock Washer - M20 | 8 |
| LAN1616 | Nyloc Nut - 3/16"-18, gr. 5 | 3 |
| LANFCJ9MC | 1-3/8" Hole Saw | 1 |

Pictorial Parts List

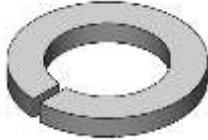
| | | | | | |
|---|---|---|---|---|---|
|  |  |  |  |  |  |
| LANSR003 (2) | LANSR015 (2) | LANSR005 (1) | LANSR006 (1) | LANSR007 (1) | LANSR008 (2) |
|  |  | |  |  |  |
| LANSR009 (4) | LANSR010 (2) | | LANSR014 (4) | LANW250100-S (2) | LANSR012 (2) |
|  |  |  |  |  |  |
| LANSR013 (1) | LANSS704 (2) | LANSKA-1 (4) | RED1F30 (2) | LAN20180 (8) | LANFWS57 (8) |
|  |  |  |  |  |  |
| REDB712 (8) | LAN690830 (24) | LAN19M7800 (1) | LAN112567 (3) | LAN120847 (6) | LANFC507 (2) |

Pictorial Parts List (continued)

| | | | | | |
|---|---|--|---|---|---|
|  |  | |  |  |  |
| LAN079UBOLT (8) | LANF3231 (4) | | LANFMLW0 (8) | LAN1616 (3) | LANFCJ9MC (1) |
|  |  | | | | |
| LANFRCRF (8) | REDB710 (8) | | | | |

Hydraulic Hose Kit

Disclaimer

This kit from LANKOTA adds 1300 lbs. to the front of a tractor. Never exceed manufacturer's specified load limit on the front of a tractor! This may mean that weights or a weight bracket may need to be removed from the tractor to install this kit.

WARNING: After completing installation, be careful around the wings the first dozen or so times they are folded/unfolded. The process of purging the air from the hoses can cause the wings to jerk up and down dangerously and unexpectedly.

Installation

1.1 Remove any weights that are on the weight bracket

IF YOU INTEND TO LEAVE THE WEIGHT BRACKET ON WITH THE KIT (Refer to Figure 1.1):

1.2 Adequately support the weight bracket and remove the bolts from one side. Install mount plate (LANSR015) and two JD8000 Spacer Plates (LANSR014) per side on the front of the weight bracket with the supplied M20 bolts (LANFRCRF) and lock washers (LANFMLW0). The mount plate should sit flat on the spacer plates and NOT contact the weight bracket. You **WILL NOT** use the frame spacers. Tighten the bolts.

1.3 Remove bolts from the other side of the weight bracket and install the other mount plate (LANSR015) and spacer plates (LANSR014) in the same fashion.

IF YOU INTEND TO REMOVE THE WEIGHT BRACKET WITH THE KIT (Refer to Figure 1.2):

1.2 Remove the front weight bracket.

1.3 Install the frame spacers (LANSR010) between the mount plates (LANSR015) and the front end of the tractor using the supplied M20 bolts (LAN20180) and lock washers (LANFMLW0).

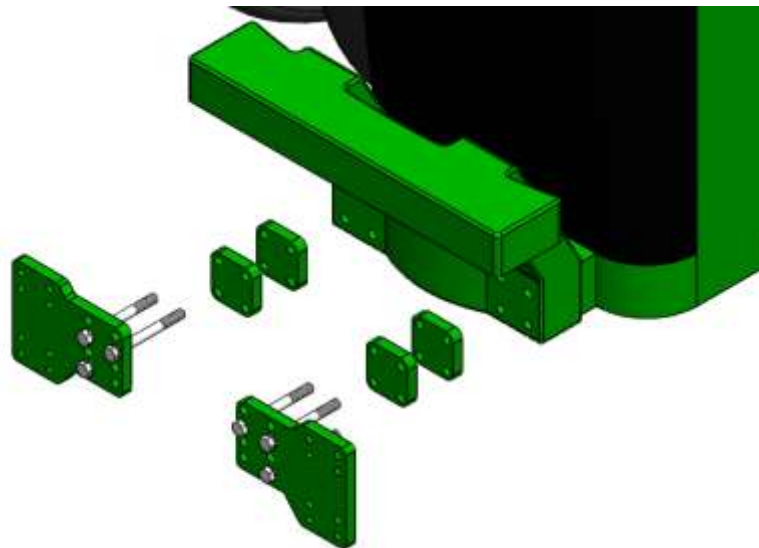

Figure 1.1

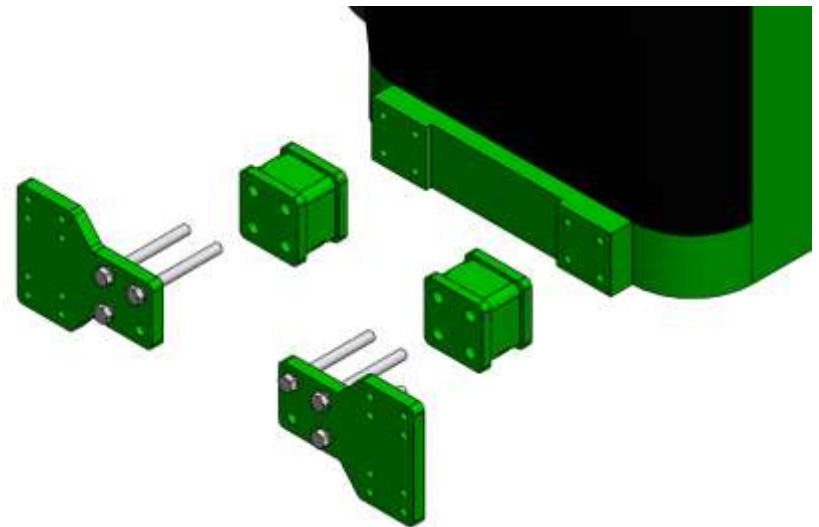

Figure 1.2

Installation

Refer to Figure 2.1

2.1 There are two sets of holes in the mount plates (LANSR004). Ideally, the top set of bolts will be 27" to 30" off the ground when the mount frame (LANSR005) is bolted to the mount plates.

Refer to Figure 2.2

2.2 Using the 5/8" bolts (REDB712), washers (LANFWS57), and serrated lock nuts (LAN690830) attach the mount frame to the mount plates. Tighten all hardware. **Make sure the washers are on the bolt head side of the plate!**

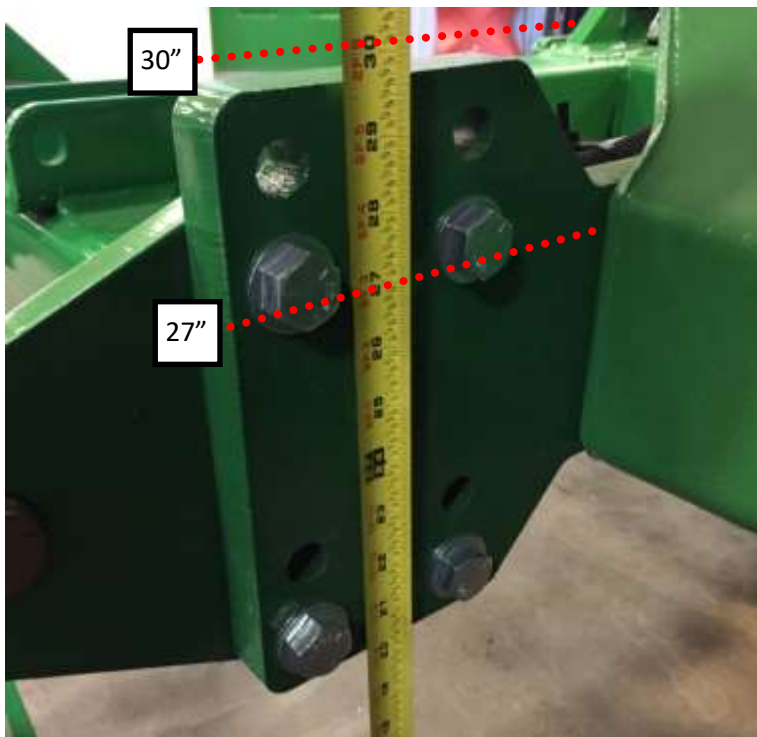

Figure 2.1



Figure 2.2

Installation

Refer to Figure 3.1

3.1 Plastic washers (LANSR009) are provided to eliminate metal to metal contact between the wing frames (LANSR006 & LANSR007) and the mount frame (LANSR005). Make sure these are in place in the following steps.

Refer to Figure 3.2

3.2 Using the pivot pin (LANSR008) attach the wing frames to the mount frame. Retain the pivot pin with the provided 1/2" bolt (LANFC507) and lock nut (RED1F30). When in the driver's seat, LANSR006 will be on your left, and LANSR007 will be on your right.

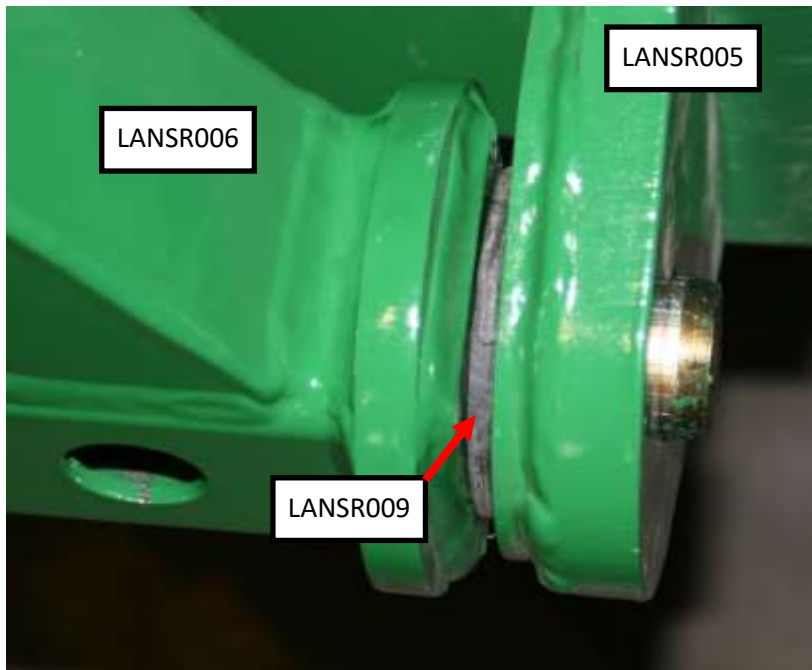

Figure 3.1



Figure 3.2

Installation

Refer to Figure 4.1

4.2 Using the provided 5/8" U-bolts (LAN079UBOLT) and serrated flange nuts (LAN690830), attach the row mounts to the stalk roller wing frames (LANSR006 & LANSR007). Make sure to position the drums so they are centered between the duals.

NOTE: The roller drum will be angled toward the back of the tractor.



Figure 4.1

Installation

Refer to Figure 5.1

5.1 Install the hydraulic cylinders (LANW250100-S) with included pins. Make sure the ports are facing toward the tractor and that the rod end is connected to the wing frames (LANSR006 & LANSR007).

Refer to Figure 5.2

5.2 When the cylinder is completely extended, the wing frame should be parallel to the ground. There is room for minor adjustments by screwing the clevis in/out of the rod.



Figure 5.1

Figure 5.2



Hydraulic Schematic

| ITEM NO. | DESCRIPTION | QTY. |
|----------|--|------|
| 1 | 9/16" MALE JIC TEE | 2 |
| 2 | 1/2" FEMALE NPT QUICK COUPLER | 2 |
| 3 | 1/2" FEMALE NPT TO 1/2" MALE NPT TEE | 2 |
| 4 | 1/2" NPT MALE NIPPLE COUPLING | 2 |
| 5 | 9/16" MALE JIC TO 9/16" MALE ORB | 2 |
| 6 | 9/16" MALE JIC TO 1/2" MALE NPT | 2 |
| 7 | 9/16" MALE JIC TO 9/16" MALE ORB 90 DEG | 2 |
| 8 | 9/16" JIC MALE TO FEMALE - 1/32" ORIFICE | 2 |

* 3/8" Diameter Hoses



Every hose end is crimped with a straight swivel flange fitting.

LANSRJD8R - Hydraulic Schematic

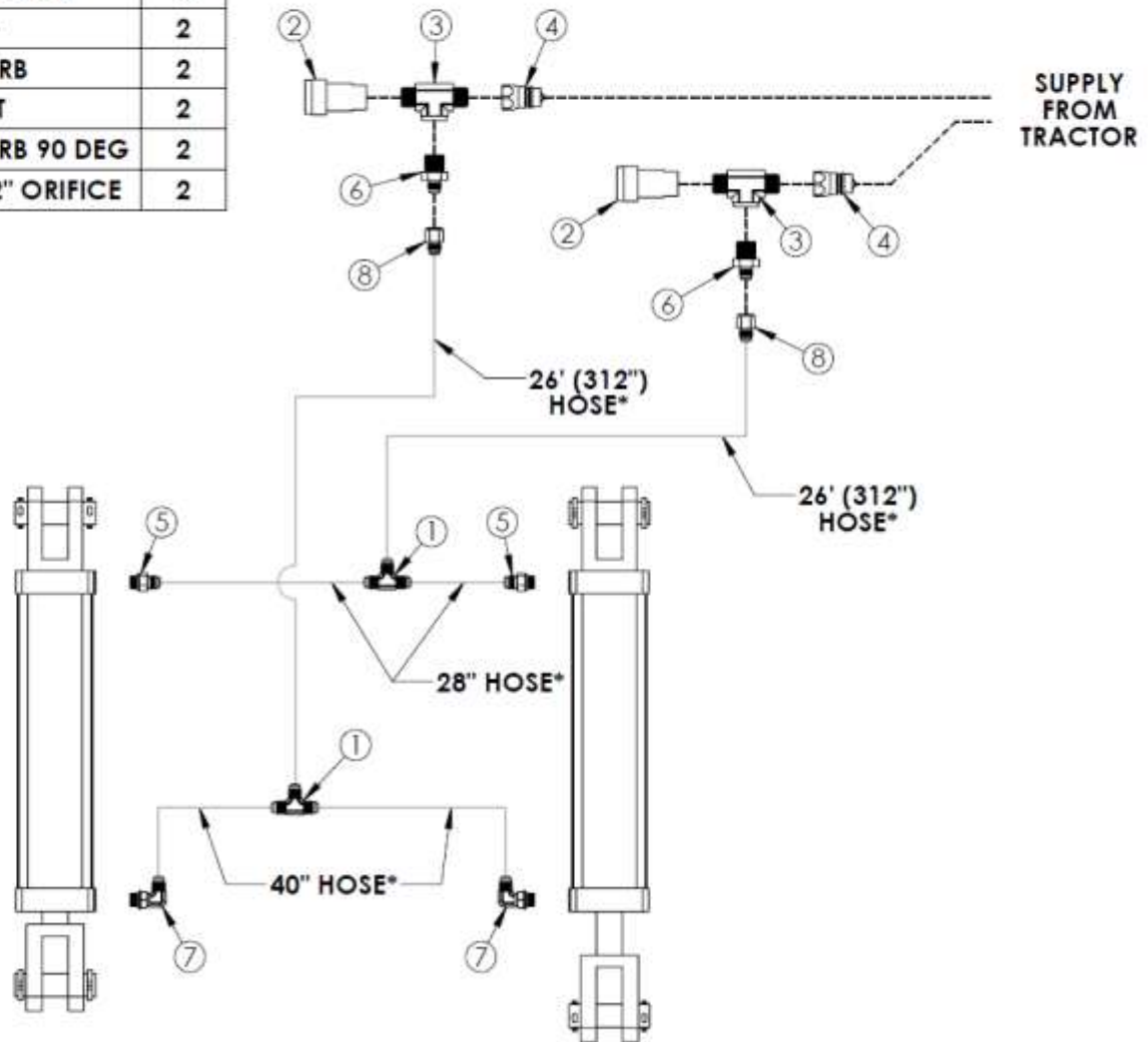

Installation

NOTE: Use the hydraulic schematic on the previous page as a reference for the following hydraulic installation procedures.

Refer to Figure 6.1

6.1 Attach a straight fitting on the base end of the cylinder and a 90 degree fitting on the rod end of the cylinder. A 28" hose will be attached to the straight fitting. A 40" hose will be attached to the 90 degree fitting. Do this on each cylinder.

Refer to Figure 6.2

6.2 Both sets of hoses will meet up and attach to the tee fittings in the middle. Make sure cylinder base hoses are together and rod end hoses are together. Also make sure that the hoses have enough freedom to move as the wing frames rotate up 90 degrees. Attach the two 312" hoses to the tee fittings and route them under the front end of the tractor.



Figure 6.1



Figure 6.2

Installation

Refer to Figure 7.1 and 7.2

7.1 Remove the plastic cover under the front of the tractor. Using the supplied 1 3/8" hole saw (LANFCJ9MC), drill two holes in the front of the cover. Then route the 3/2" hoses through these holes and re-mount the plastic cover. These hoses will come through the frame, along the right side of the tractor (as you sit in the cab).



Figure 7.1

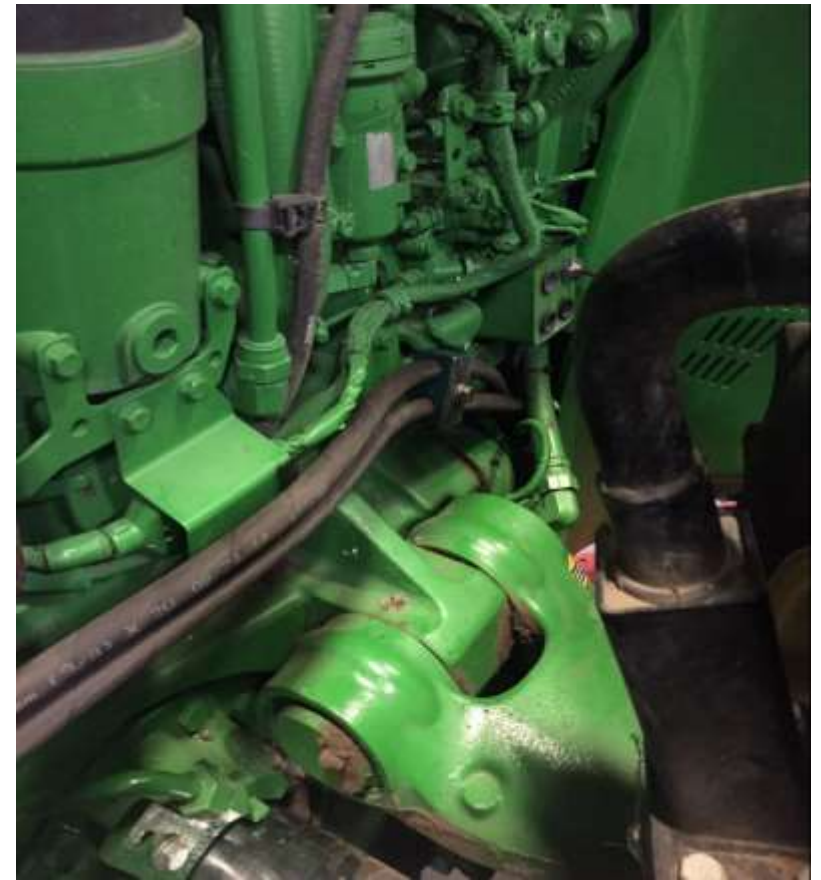

Figure 7.2

Installation

Refer to Figure 8.1 and 8.2

8.1 Run the hoses along the side of the tractor. Where applicable, attach to the tractor frame using the included bolts (LANSR012 & LANSR013), hose holders (LAN120847 & LAN112567), and lock nut (LAN1616).

NOTE: Make sure the hoses will not be crushed when the front wheels are turned all the way to the right.

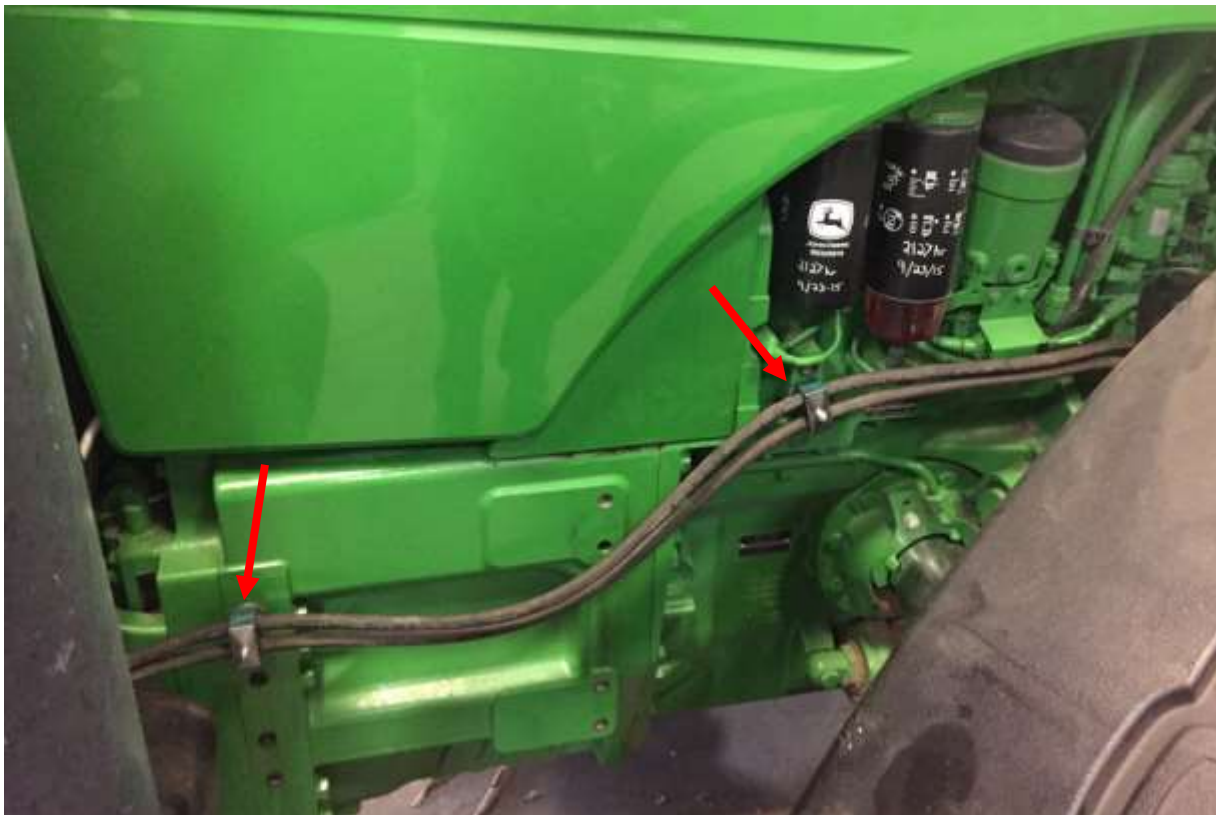

Figure 8.1



Figure 8.2

Installation

Refer to Figure 9.1 and 9.2

9.1 Route the hoses out the back of the tractor. Attach the hose to the NPT tee fitting and quick couplers as shown in the schematic. They can now be plugged into one of the auxiliary ports at the back of the tractor.

NOTE: Do a quick check to make sure all fittings are tight, all hoses are restrained properly and none of them are dangling below the tractor.



Figure 9.1



Figure 9.2

Installation

Refer to Figure 10.1 and 10.2

10.1 Two pins (LANSS704) are included to hold the wing frames UP during long term storage. The purpose is to keep the hydraulic cylinders from settling. An extra hole is provided for storage of the pin while the rollers are in use.

Storage Position



Figure 10.1

Operating Position



Figure 10.2

Headlight Clearance Consideration

Refer to Figures A, B & C

If additional light clearance is required, install cylinder stops (LANSCA-1) as necessary (one or two) on each cylinder to hold the roller arms away from the lights.

Note: The cylinder stops will need to be removed in order to utilize the storage pin position (See

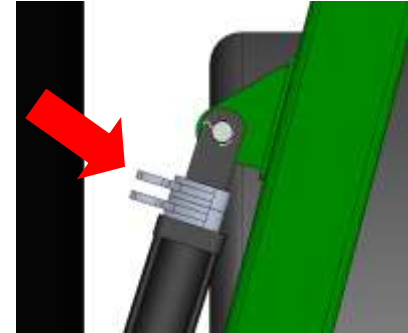

Figure A

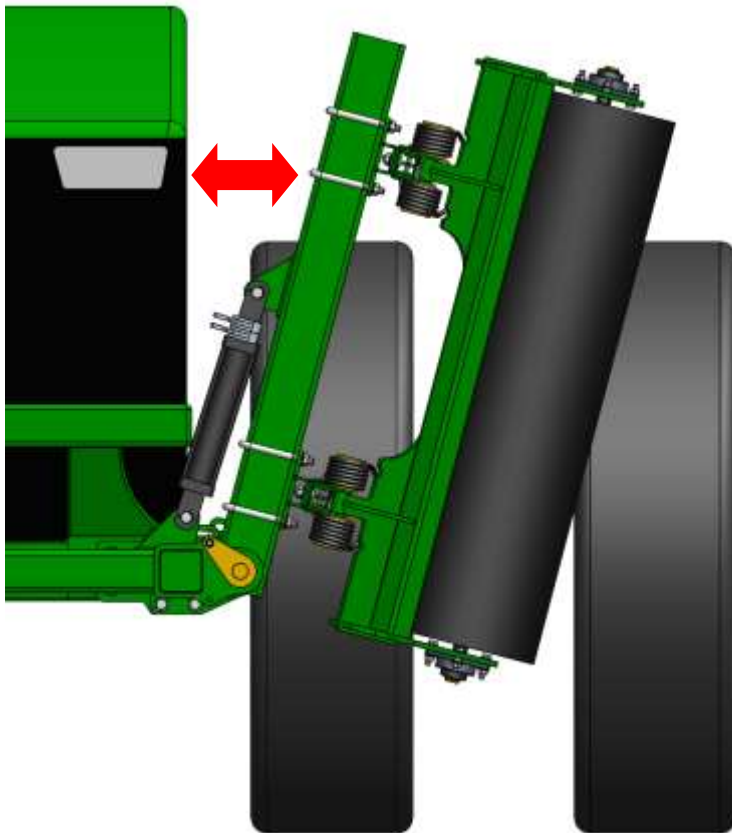

Figure B

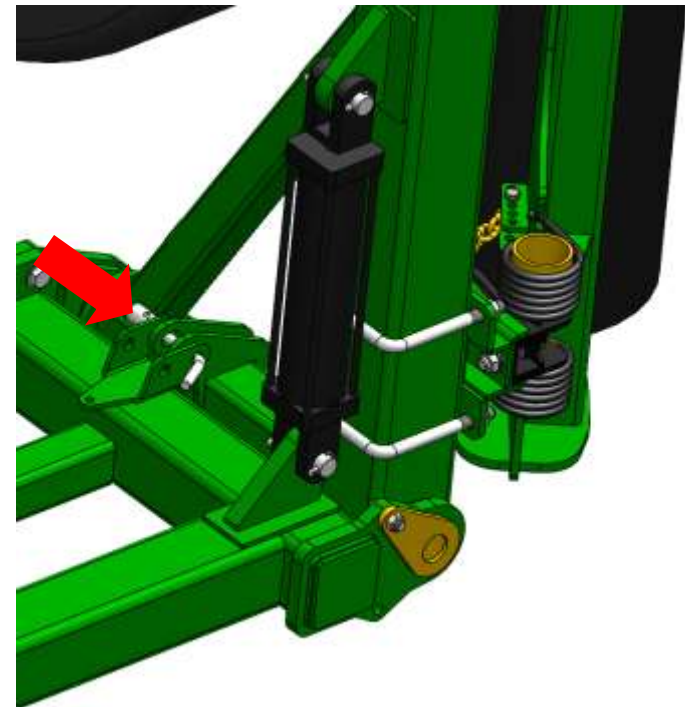

Figure C

Stalk Roller Disclaimer

Stalk Roller Disclaimer

The most effective use of the Lankota Stalk Roller is achieved by adjusting the chain on the roller so that when they are unfolded, the roller drum is just touching the ground and the spring is not compressed. Over compression of the spring can shorten the life of the roller spring and may result in undue damage NOT covered by Lankota's Limited Warranty.



For further technical assistance,

call Lankota Inc. at:

1-866-526-5682