

LAN84211-1.5

Installation Instructions

Cutting Platform Wedge Kit 1.5 Degree Angle Addition

LANKOTA[®]

270 West Park Avenue

Huron, SD 57350

866-526-5682

Numerical Parts List

<i>Part Numbers</i>	<i>Description</i>	<i>Quantity</i>
LAN205653	Seal Retrofit Platform Angle	1
LAN206179	Bracket, Platform Retrofit Angle	2
LAN206180	Bracket for Platform Wedge Kit	2
LAN205605	Plate for Platform Wedge Kit	2
LAN205622	Platform Seal Retrofit Wedge Kit	2
LAN206184 (right)	Platform Wedge Kit Angle Bracket	1
LAN205484 (left)	Platform Wedge Kit Angle Bracket	1
LAN19M7843*	M16-20 x 35mm Bolt	8
LAN201027*	25mm Screw	6
LANSM8P7*	M8 x 1.25 Plus Nut	8
LANY1GC7*	M8 x 30mm Bolt	4

**included in bag of hardware.*

Pictorial Parts List

 <p>LAN19M7843 (8)*</p>	 <p>LAN201027 (6)*</p>	 <p>LANSM8P7 (8)*</p>	 <p>LANY1GC7 (4)*</p>
 <p>LAN205653 (1)</p>	 <p>LAN206179 (2)</p>	 <p>LAN206180 (2)</p>	 <p>LAN205605 (2)</p>
 <p>LAN205622 (2)</p>	 <p>LAN206184 (1) (R)</p>	 <p>LAN205484 (1) (L)</p>	

Preparation

1. Remove platform from the combine.
2. Place platform on a header trailer or lower onto blocks to create a safe and adequate clearance to the feederhouse opening and the bottom of the torque tube.
3. Position the combine on level ground.

1. Determining the Correct Amount of Angle

Refer to Figure 1.1

- 1.1 Position the feeder house so it is perpendicular to the ground. Use a level on front surface to obtain this.
- 1.2 Measure from center of driveshaft to the ground.

Refer to Table #1

- 1.3 From the following table determine the correct wedge angle to install.



Figure 1.1

Table 1

STS Combines		CWS and CTS Combines	
Figure A	Wedge Angle	Figure A	Wedge Angle
Less than 28 in.	0	Less than 21.5 in.	0
28 – 30.5 in.	1.5	21.5-29.5 in.	1.5
30.5-32.5 in.	3	29.5-31 in.	3
More than 32.5 in.	4.5	More than 31 in.	4.5

2. Installing the Cutting Platform Wedge Kit

Refer to Figure(s) 2.1 & 2.2

2.1 Remove both wear plates from header bracket by removing the two nuts and bolts. Retain wear plates for reassembly later in these directions.

2.2 Remove existing header and attach brackets from 5" tube with a cutting torch or other appropriate cutting tool. **Do not cut or grind 5" mainframe tube.** Do this in a properly ventilated area with safety glasses & proper safety equipment.

Figure 2.1



Figure 2.2

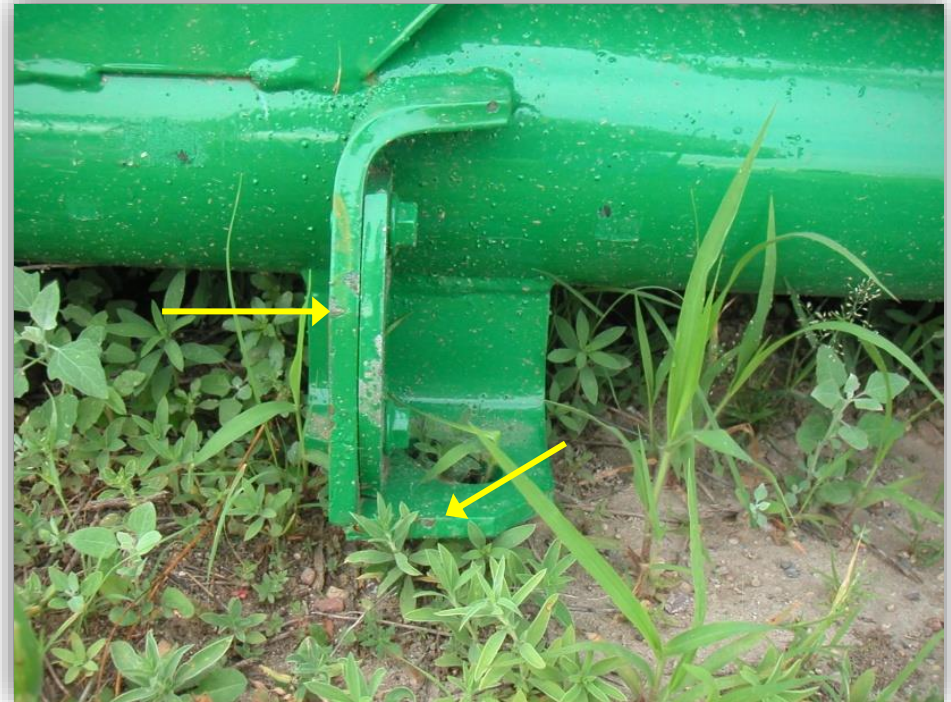

Refer to Figure 2.3

- 2.3 Once the support bracket is removed, grind away all loose slag and metal so it is flush with the 5" tube.
- 2.4 Using a straight edge, draw a vertical line from *left hand* side of vertical support on *left hand* side of header down across the 5" tube. See line A.
- 2.5 From the line marked on the 5" tube, measure four inches towards outside of header and draw another line parallel with the first line. Repeat for right hand side of header as well. See line B.
- 2.6 Position Bracket (LAN205484) parallel to the 5" tube on the left side of feeder house opening. Position Bracket (LAN206184) parallel to the 5" tube on the right side of feeder house opening using a straight edge. Bracket must be flush with line B which is shown in Figure 2.3.

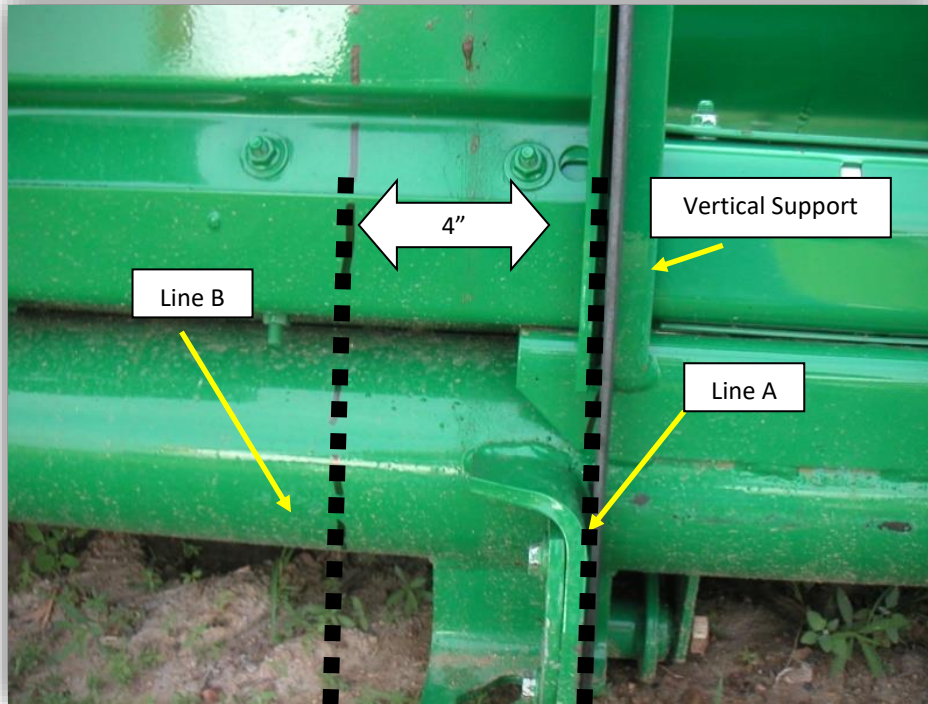

Figure 2.3

Refer to Figure 2.4

2.7 Place the bracket on the marked lines and tack weld in place and check to make sure positioning is correct.

Refer to Figure 2.5

2.8 Continue to weld the bracket on each end, across the entire top, and the inside gusset.

2.9 To prevent rust, clean, prime, and paint the affected areas.

2.10 Attach wedge brackets (LAN206180) to the 5" tube bracket as shown below. Mount with 2 bolts (LAN19M7843) on each side, with the back of the brackets towards the center of the head as shown.

2.11 Attach original wear brackets using original hardware removed from figure 2.1

Note: Zero degree wedge brackets (LAN206179) are included in bundle so platform may be converted back to its original angle if necessary.

Refer to Figure 2.6

2.12 Attach one spacer block (LAN205605) to both 5" tube brackets with 2 Bolts (LAN19M7843) on each side.

Figure 2.4



Figure 2.5

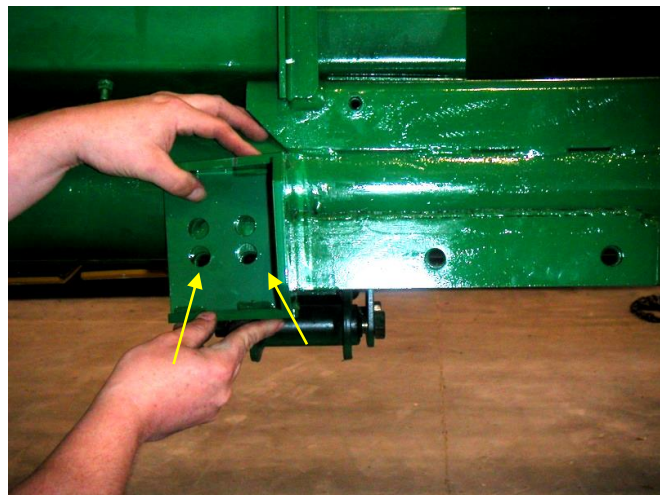
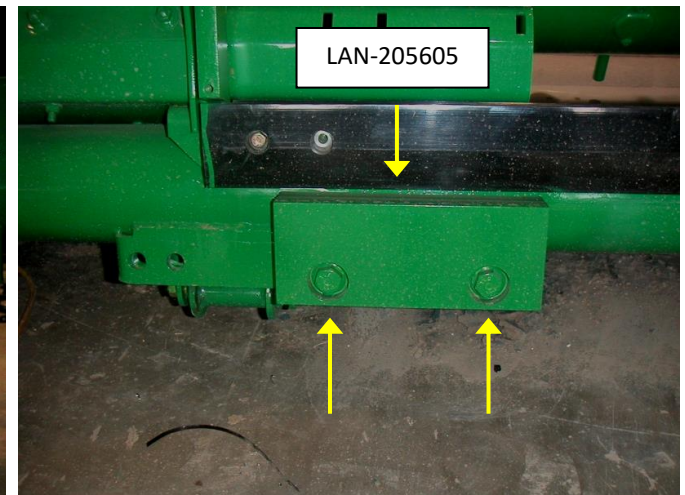

Figure 2.6



3. Horizontal Seal Application

Refer to Figures 3.1 & 3.2

3.1 Attach seal (LAN 205653) to header using the 4 holes with RIVNUTS that are already provided in header with 4 bolts (LANY1GC7)

NOTE: Some earlier serial number heads may not have correct RIVNUT spacing for seal attachment. Therefore we have provided extra RIVNUTS with this kit. If new spacing of RIVNUTS is required follow these instructions:

1. *Align and center the seal (LAN205653) on feed floor back between the vertical supports. Mark the four holes through the seal on the head and center punch. Remove the seal.*
2. *Using a 7/16 drill bit, drill the four new holes (FIGURE 3.2). Install four RIVNUTS (LANSM8P7) in newly drilled holes. If you do not have the special tool to expand RIVNUTS you can spot weld the RIVNUT in two places then use an 8mm bolt and 6 washers to expand it. After expanding, grind the spot welds flush and paint.*

Figure 3.1



Factory set RIVNUTS

Figure 3.2

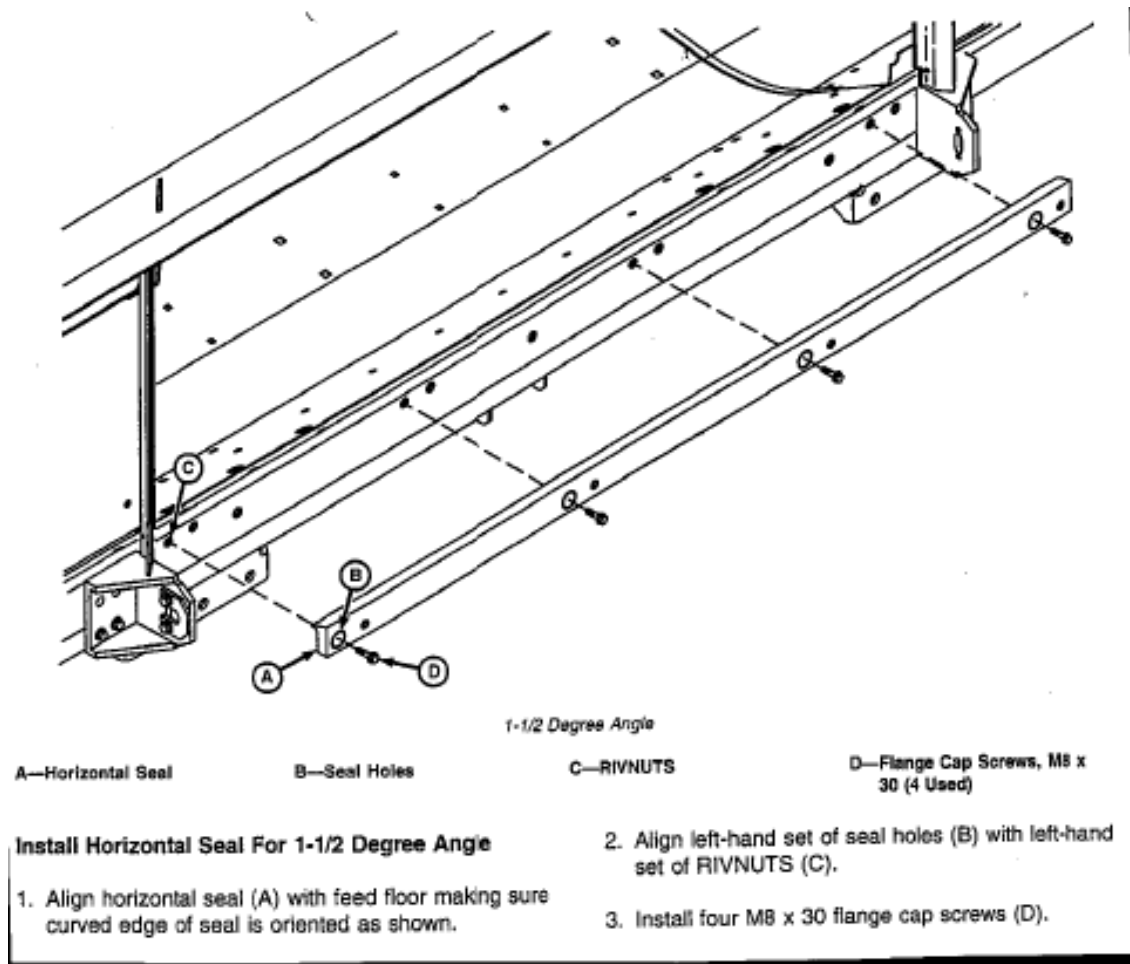

4. Installing Vertical Seals

Refer to Figure 4.1

- 4.1 Measure 34 mm up from the bottom edge of the vertical support on each side of the feeder house opening and mark (Dimension A).
- 4.2 Measure up 175 mm from Dimension A and mark (Dimension B).
- 4.3 Measure up 150 mm from Dimension B and mark (Dimension C).
- 4.4 Center all of the holes in the vertical support by measuring out from the inside of vertical support 10mm.
- 4.5 Checking measurements and centering and then drill at the three dimension marks with an 11/32" drill bit.
- 4.6 Repeat for other side.

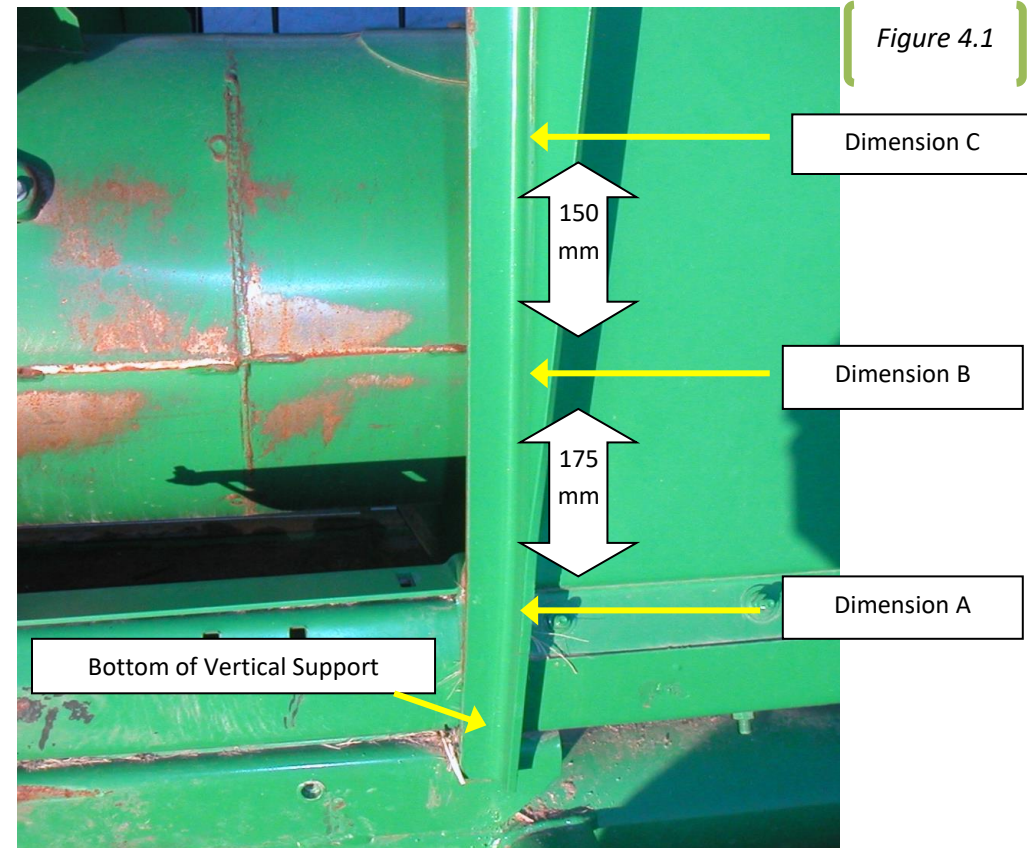

Refer to Figure 4.2

- 4.7 Align vertical seals (LAN205622) (narrow end up) with feeder house vertical support and install with three bolts (LAN201027).
- 4.8 Repeat procedure on right side of header.
- 4.9 When all seals have been properly installed, inspect for gaps, and caulk as necessary.

NOTE: It will be necessary to block the front of the head to facilitate unhooking and hooking up when placing on a flat surface.

For further technical information,

Contact Lankota at:

1-866-526-5682

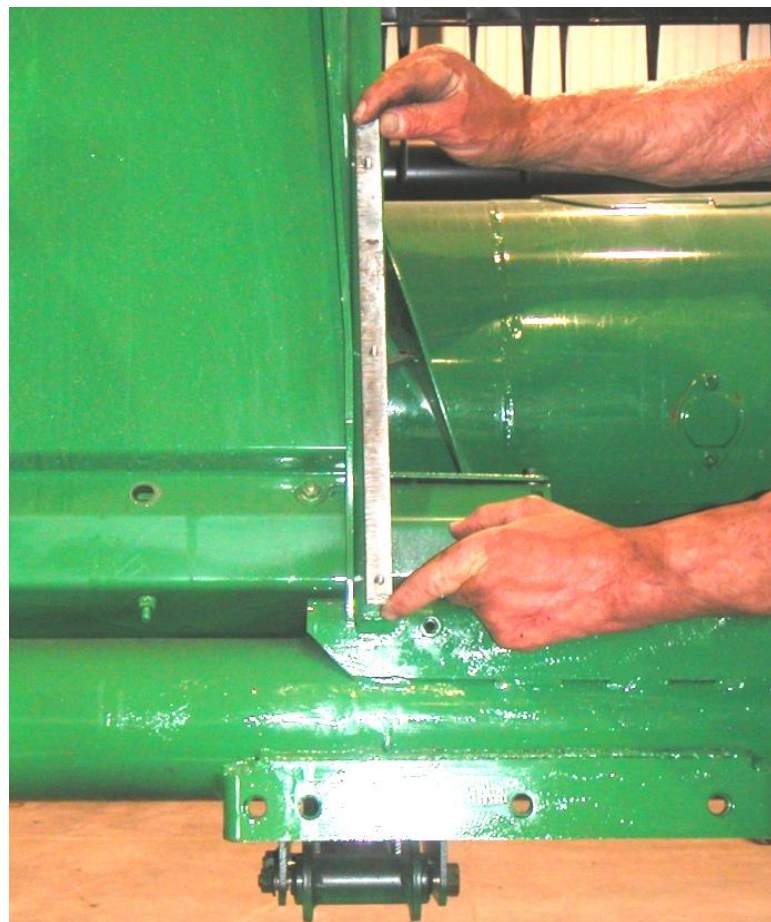

Figure 4.2