

LAN84208

Installation Instructions

Single Point Hydraulic/Electrical Conversion Kit for 50 Series Walker and CTS Combines

LANKOTA[®]

270 West Park Avenue

Huron, SD 57350







866-526-5682

Approximate Installation Time: 6 hours

Numerical Parts List

<i>Part Numbers</i>	<i>Description</i>	<i>Quantity</i>
LANH201368	Single Point Hydraulic Cover	1
LANH202240	Seal Strip	2
LANAH206278	Single Point Mount Bracket	1
LANAH204601	Hose Cover Mount Bracket	1
LANH204885	Hose Cover	1
LAN3PLK-0-5BFC	Combine Half of Single Point	1
LAN84208HK	Hose Kit	1
	yellow, reel drive hose	1
	red, reel return hose	1
	light blue, reel fore hose	1
	dark blue, reel aft hose	1
	green, reel lift hose	1
	no color, variable speed hose	1
RED-TRC-TAPE	Anti-Skid Tape	1
LAN209735	Wiring Harness	1
LANH175881	Wiring Harness Snap Ring	1
LAN6FF	Hydraulic Cap	2
LAN84207/9BH	Bag of Hardware	1
	LAN19M7784 M10 x 20 Flange Head Bolt	2
	LAN14M7296 M10 Serrated Flange Lock Nut	2
	LAN19M7865 M8 x 15 Flange Head Bolt	4
	LAN14M7298 M8 Serrated Flange Lock Nut	2
	LAN37M7092 M8 x 15 Self Tapping Bolt	5
	REDVTG5 24" Cable Ties	12

Pictorial Parts List

					
LAN209735	LAN204885	LANAH206278	LANAH204601	LANH202240 (2)	
					
LANH175881	LANH201368	LAN3PLK-0-5BFC	LAN14M7296 (2)	LAN19M7865 (4)	LAN6FF (2)
					
LAN14M7298 (2)	LAN37M7092 (5)	LAN19M7784 (2)	LANAH206909 (COLOR)	LANAH206906 (Light Blue)	LANAH206913 (COLOR)
					
LANAH206904 (GREEN)	LANAH206907 (Dark Blue)	LANAH208408	REDVTG5 (12)	RED-TRC-TAPE (1)	

1. Preparation

- 1.1 Park combine on clean level surface. Lower feeder house to the ground.
- 1.2 Position feeder house on jack stands and continue to depress switch for 5 seconds to relieve hydraulic system pressure.
- 1.3 Shut off engine, remove key.
- 1.4 Set parking brake.

2. Installation

Refer to Figure 2.1

- 2.1 Remove quick-lock pin (A) to remove rear shield.
- 2.2 Release rubber strap (B) on feeder house to open shield. Remove cap screw (C) holding shield. Remove shield.

Figure 2.1

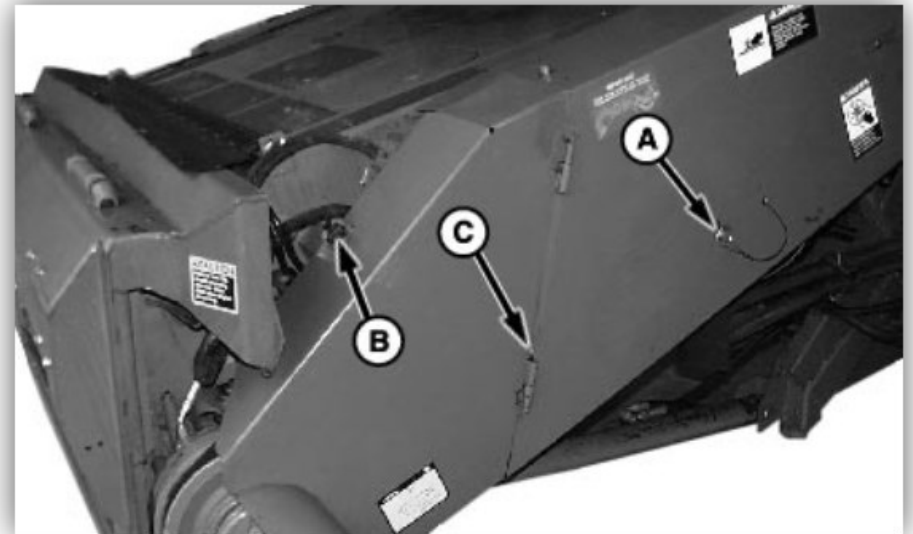

Refer to Figure 2.2

2.3 Loosen cap screw (A), but do not remove.

2.4 Remove quick-lock pins (B) and pull shield (C) forward.

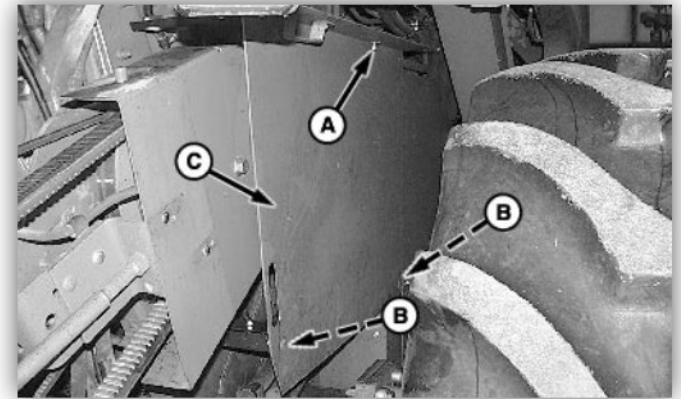

Figure 2.2

Refer to Figure 2.3

2.5 Remove quick-lock pin (A) and shield (B).

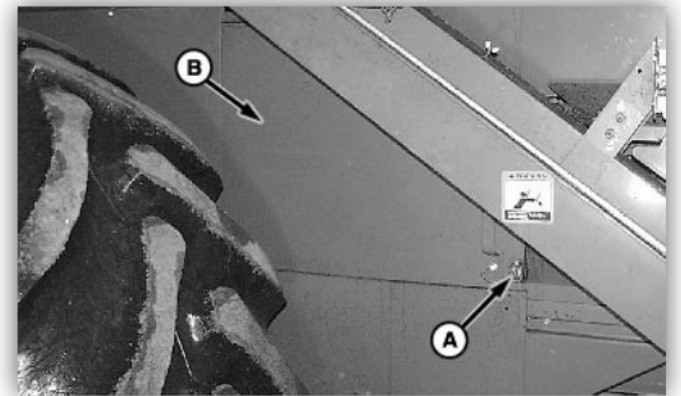

Figure 2.3

Refer to Figure 2.4

2.6 Remove and retain cap screws (A) from shield (B). Remove shield.

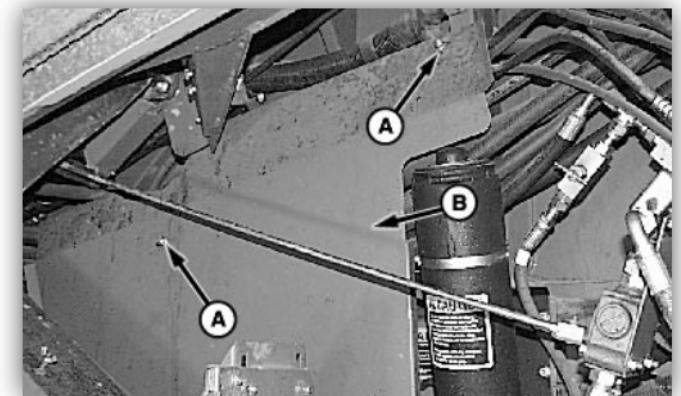

Figure 2.4

Refer to Figure 2.5

2.7 IF EQUIPPED WITH CONTOUR MASTER™: Remove quick-lock pin (A) from pipe (B).

2.8 IF EQUIPPED WITH CONTOUR MASTER™: Push pipe through opening and lay tube and rubber seal indicator (C) out of the way.

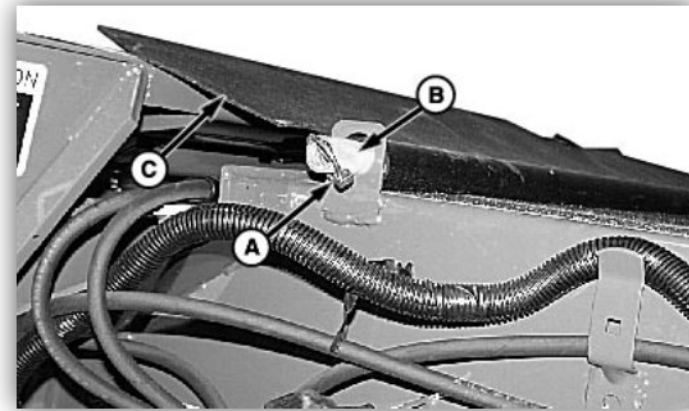

Figure 2.5

Refer to Figure 2.6

2.9 IF EQUIPPED WITH CONTOUR MASTER™: Position multi-coupler bracket (A) (LANAH20678) and center bracket over curtain hanger (B).

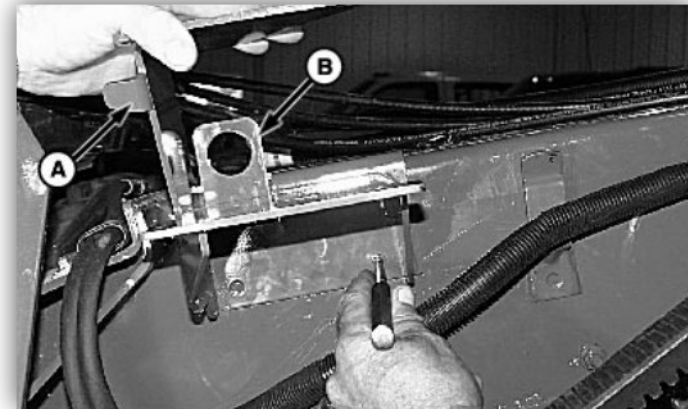

Figure 2.6

Refer to Figure 2.7

2.10 COMBINES WITHOUT CONTOUR MASTER™: measure from feeder house pivot casting edge (A) to edge of multi-coupler bracket (B) (LANAH20678) a distance (C) of 37 3/8 in. for level land machines or 34 5/8 in. for Sidehill machines.

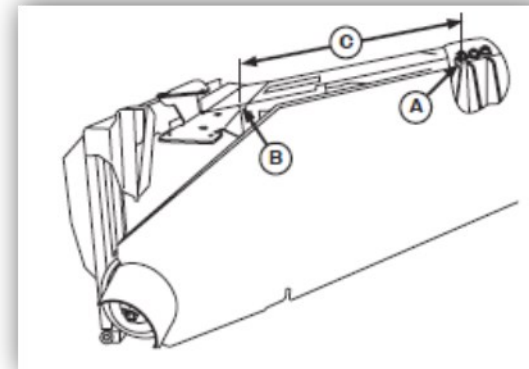

Figure 2.7

Refer to Figure 2.8

2.11 Using bracket as a template, locate and mark holes (A).

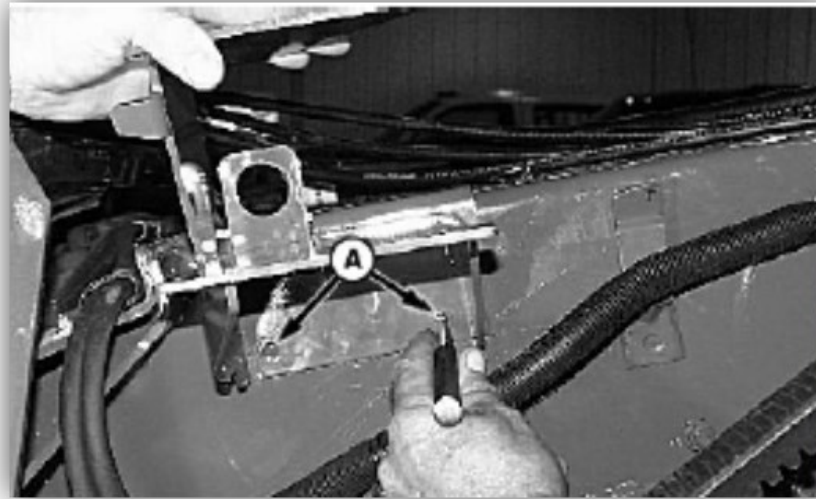

Figure 2.8

Refer to Figure 2.9

2.11 Locate and mark hole locations (A) on top side of the feeder house through holes of multi-coupler bracket (B) (LANAH20678).

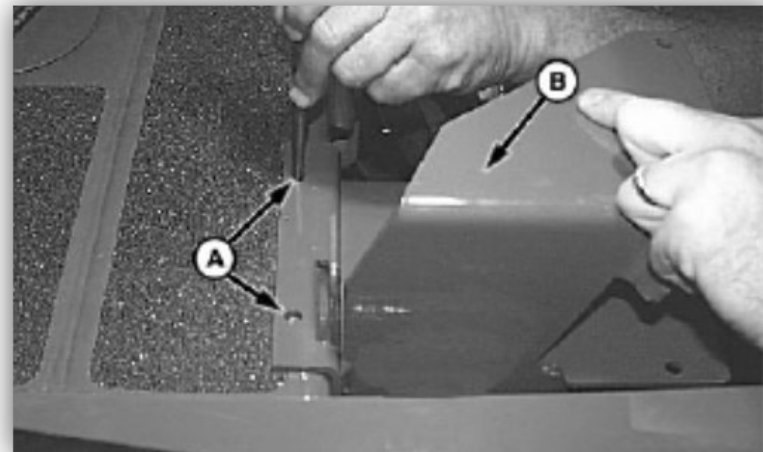

Figure 2.9

Refer to Figures 2.10 & 2.11

2.12 Drill two 7/16" holes (A)

Note: DO NOT drill hole larger than 7mm (9/32") in feeder house. Bracket holes on top are held with two self tapping screws.

2.13 Drill two 9/32" holes (B)

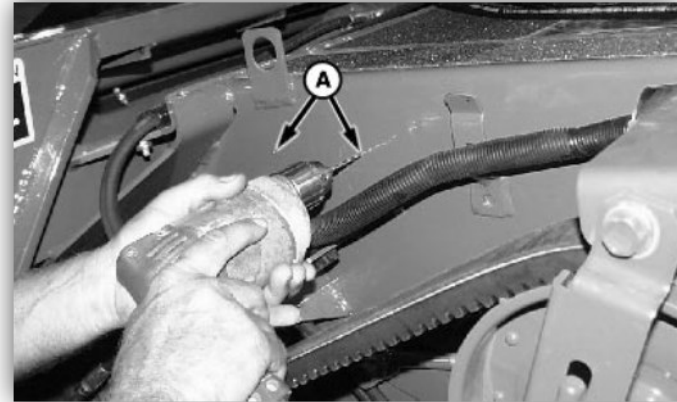

Figure 2.10

Refer to Figure 2.12

2.14 IF EQUIPPED WITH CONTOUR MASTER™: Install multi-coupler bracket (A) (LANAH20678) over curtain hanger (B) and retain using two M8 x 15 self tapping screws (LAN37M7092) (C). Combines without CONTOUR MASTER™ and Sidehill Combines: Install multi-coupler bracket (A) and retain using two M8 x 15 self tapping screws (LAN37M7092) (C).

2.15 Open top feeder house access door to install M10 x 20 flange head bolts (LAN19M7784) and retain using M10 lock nuts (LAN14M7296) (D).

2.16 IF EQUIPPED WITH CONTOUR MASTER™: Install pipe through rubber seal indicator and retain using quick-lock pin (E).

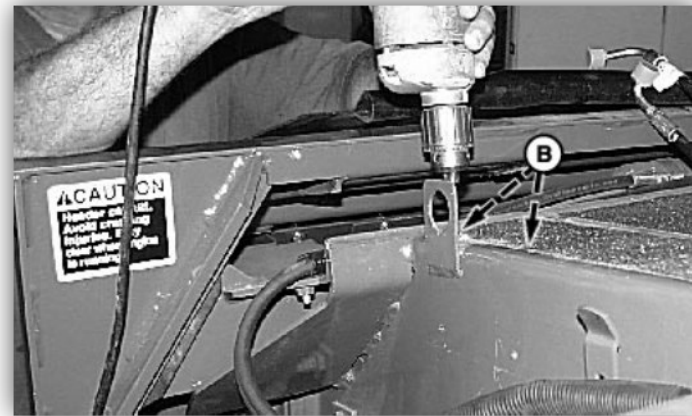

Figure 2.11

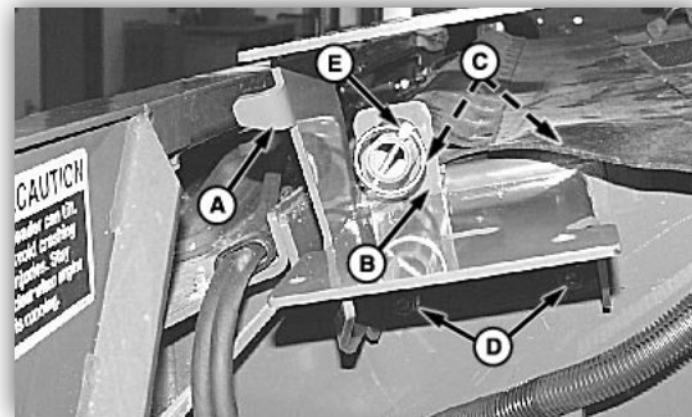

Figure 2.12

Refer to Figure 2.13

2.17 Locate bracket (A) (LANAH204601) a distance of 3 ½" away from the feeder house pivot casting edge.

2.18 Locate bracket (LANAH204601) a distance of 11/16" in from edge (C).

Note: DO NOT drill hole larger than 9/32 in. in the feeder house. Bracket holes on top are held with two self tapping screws.

2.19 Locate, mark, and drill two 9/32" holes.

2.20. Attach bracket (LANAH204601) to feeder house using two M8 x 15 self tapping screws (LAN37M7092).

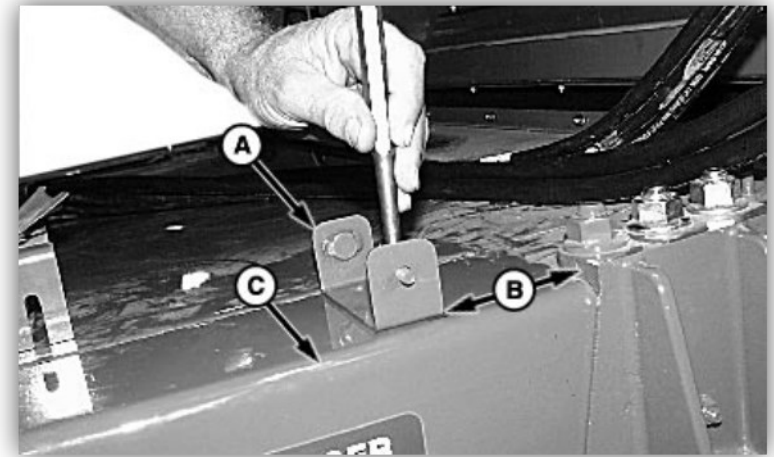

Figure 2.13

Refer to Figure 2.14

2.21 Install hose cover (A) (LAN204885) onto welded on stud bolts (B).

2.22 Use hose cover (LAN204885) as template to locate hole (C).

Note: DO NOT drill hole larger than 9/32" in the feeder house. Bracket hole on top is held with a self tapping screw.

2.23 Locate, mark, and drill a 9/32" hole.

NOTE: DO NOT leave a vacuum pump running for extended period of time. Remove components and cap lines. Extended use may burn up vacuum pump.

2.24 Install vacuum pump on hydraulic reservoir. This will allow the removal of hydraulics hoses without draining the reservoir. If vacuum pump is not available, drain reservoir.

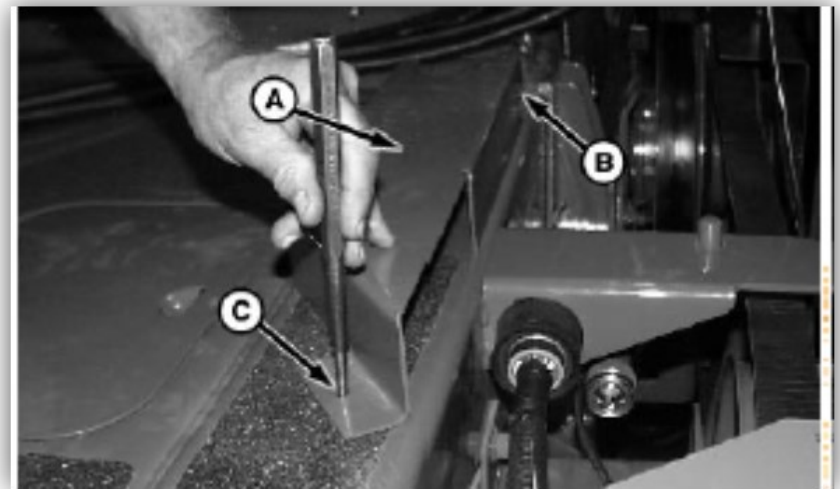

Figure 2.14

Refer to Figure 2.15

NOTE: To prevent bending or damaging the reel speed control valve, retain the valve with one hand, while loosening hydraulics fittings with a wrench.

Use a clean container to catch any left over hydraulic fluid. Plug lines when hoses are removed to prevent fluid from escaping.

2.25 Remove reel drive priority hose (A) and reel drive return hose (B) from reel speed flow control valve (C).

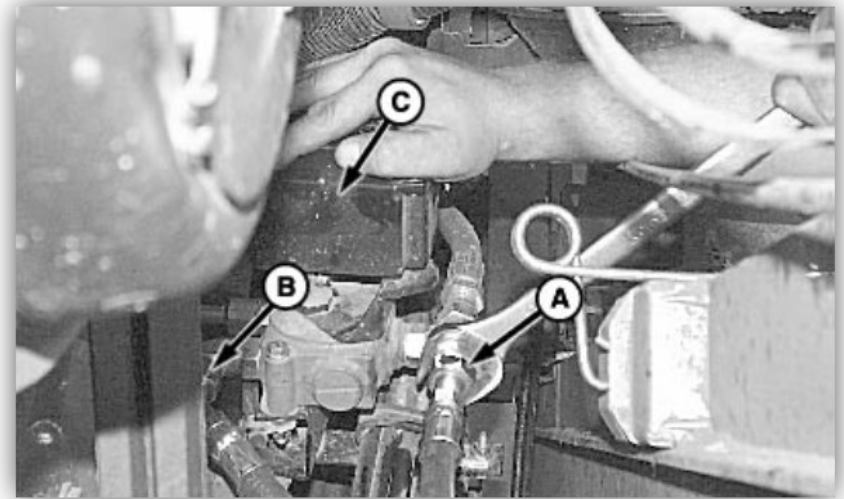

Figure 2.15

Refer to Figure 2.16

2.26 Remove reel extend hose (light blue) (if equipped) (A), reel retract hose (dark blue) (if equipped) (B), and reel lift hose (light green) (C).

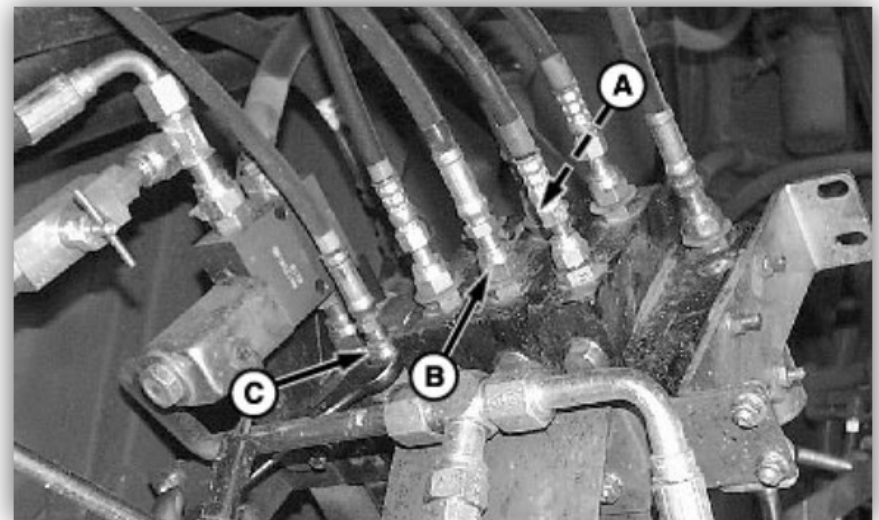

Figure 2.16

Refer to Figure 2.16

2.27 Remove and retain hardware (A), bracket (B), and hose clamp (C).

2.28 Remove and retain hardware (D) and hose clamp (E).

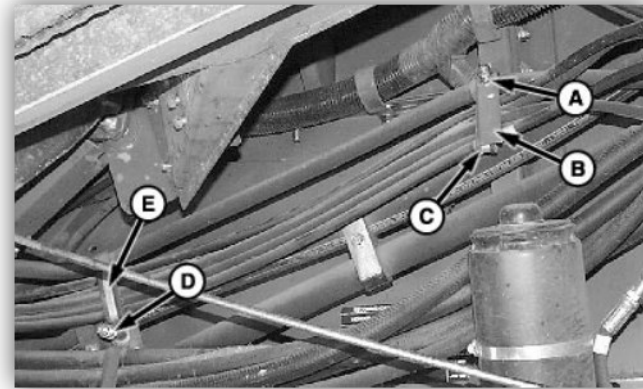

Figure 2.16

Refer to Figures 2.17 & 2.18

2.27 Remove and retain lock nuts and cap screws (A).

2.28 Remove and retain hose clamps (B) from hydraulic hoses.

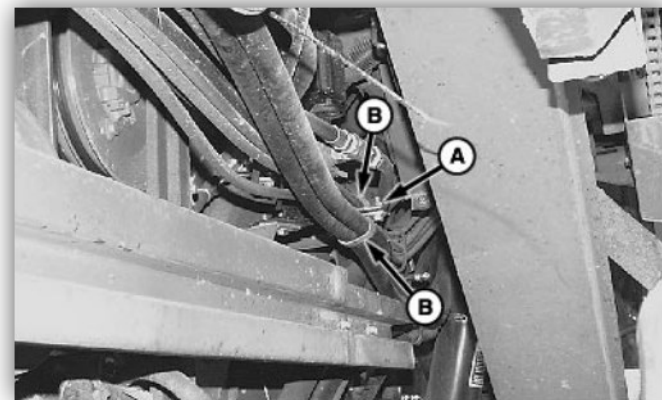

Figure 2.17

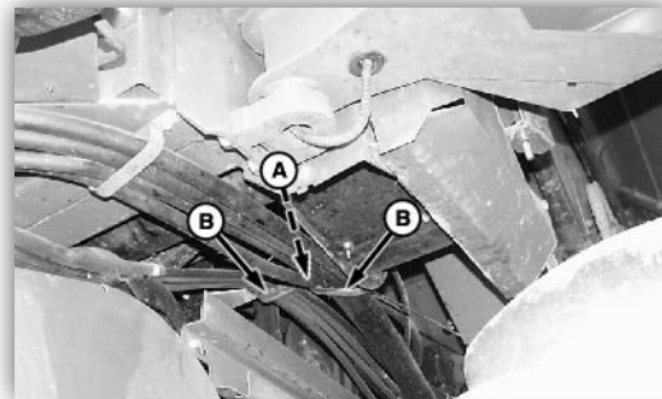

Figure 2.18

Refer to Figure 2.19

2.29 Remove and retain lock nuts and cap screws (A).

2.30 Remove and retain hose clamps (B) from hydraulic hoses.

2.31 Remove and retain self tapping screw (C).

2.32 Remove and discard hose clamp (D) from hydraulic hoses.

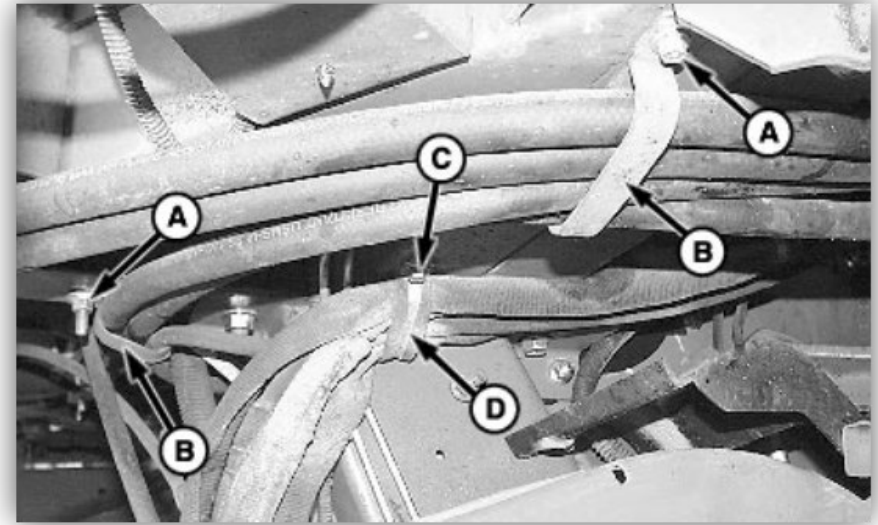

Figure 2.19

Refer to Figure 2.20

2.33 Remove and discard self tapping screws (A) from under cab.

2.34 Remove and discard hose clamps (B) from hydraulic hoses.

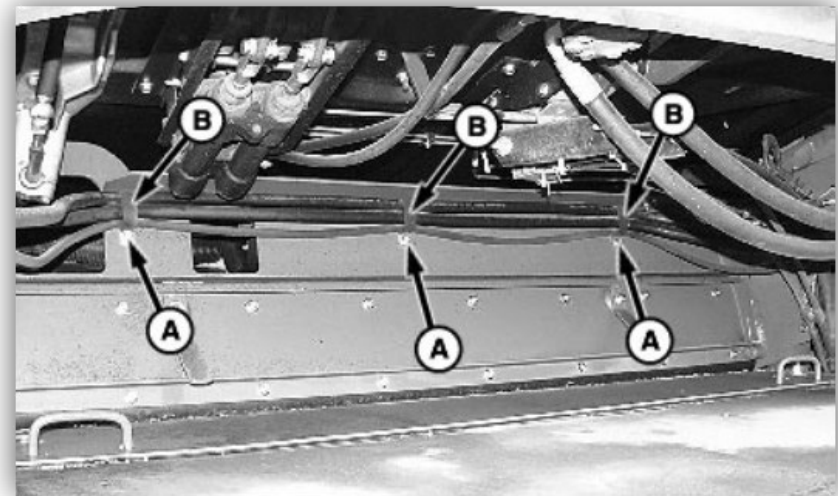

Figure 2.20

Refer to Figure 2.21

2.35 Remove and discard lock nut and cap screw (A).

2.36 Remove and discard hose clamp (B) from hydraulic hoses.

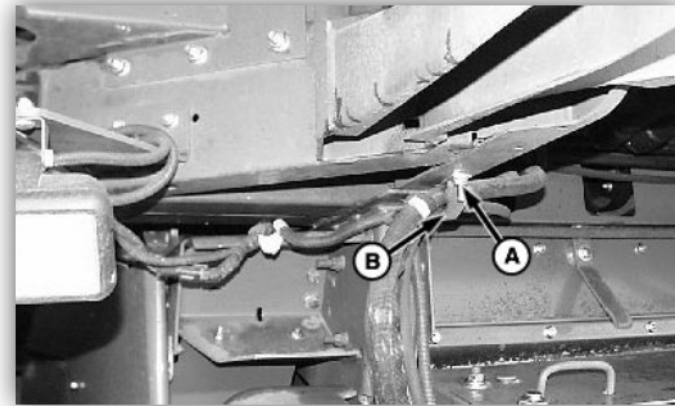

Figure 2.21

Refer to Figure 2.22

2.37 Raise rubber strap (A) on right-hand feeder house shield (B) to open.

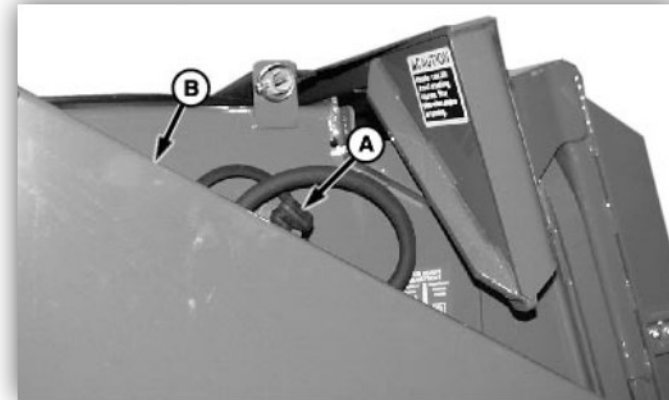

Figure 2.22

Refer to Figure 2.23

2.38 Remove quick-lock pin (A) to remove rear shield (B).



Figure 2.23

Refer to Figure 2.24

2.39 Remove and discard lock nut (A), cap screw (B), and hose clamp (C).

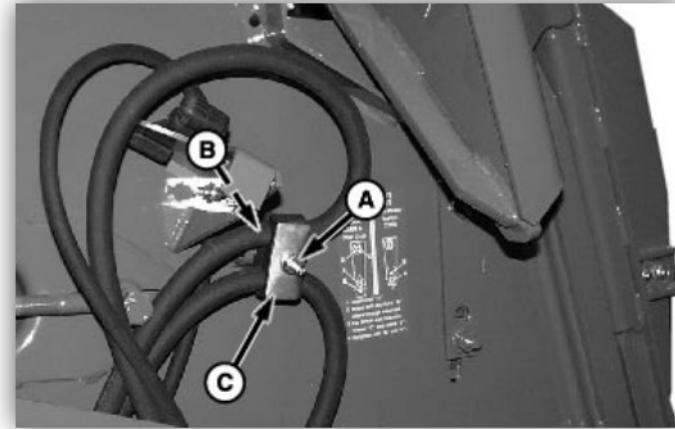

Figure 2.24

Refer to Figure 2.25

2.40 Remove and discard lock nut (A), cap screw (B), and hose clamp (C).

2.41 Push hydraulic hoses through opening in feeder house (D) and discard.

2.42 Install and retain right-hand feeder house shields.

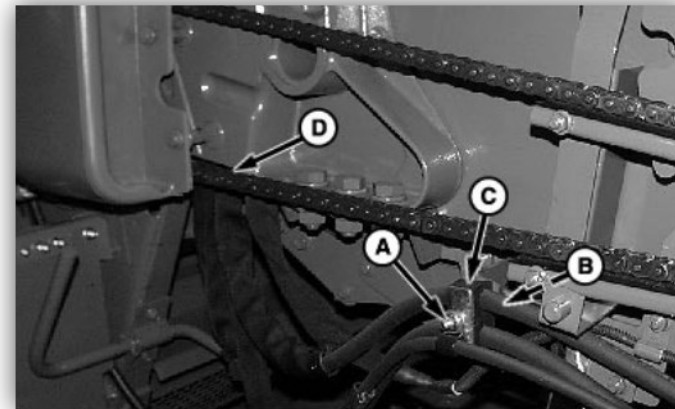

Figure 2.25

Refer to Figure 2.26

2.43 Remove and retain lock nut (A), hose clamp (B) (if equipped), electrical harness clamp (C) located above variable speed feeder house belt (D).

2.44 Remove and discard hose clamp (E) retaining reel lift hose (F) and reel retract hose (G).

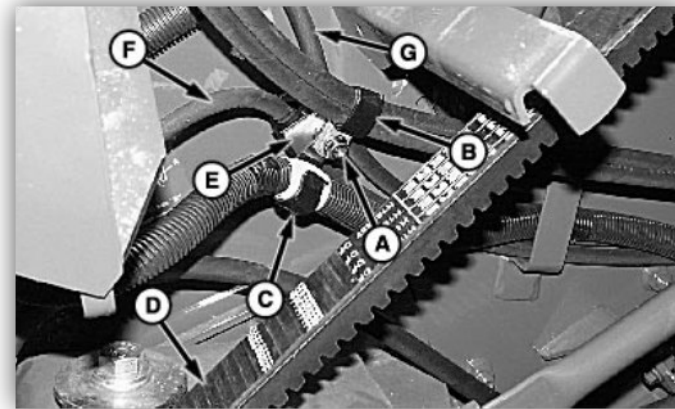

Figure 2.26

Refer to Figure 2.27

2.45 Install electrical harness clamp (A) and hose clamp (B) (if equipped) with new cap screw and retain with lock nut (C).

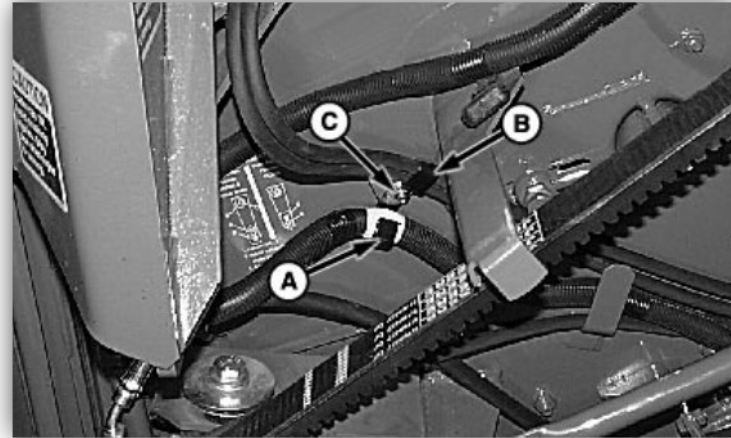

Figure 2.27

Refer to Figure 2.28

2.46 Remove and retain lock nut (A), hose clamp (B) (if equipped) and electrical harness clamp (C).

2.47 Remove and discard hose clamp (D), retaining reel lift hose (E) and reel retract hose (F).

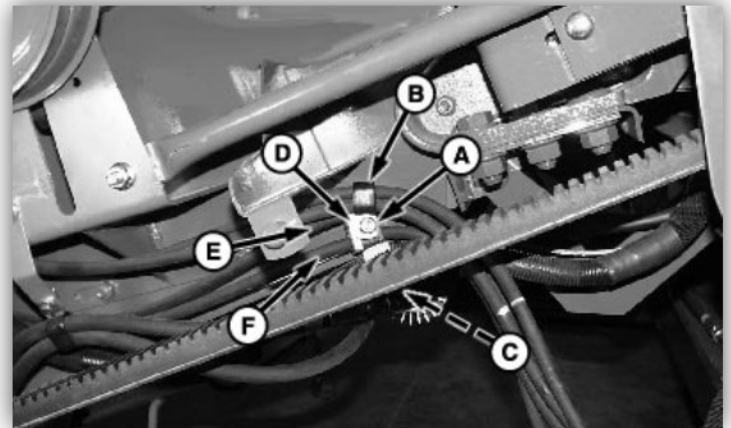

Figure 2.28

Refer to Figure 2.29

2.48 Install electrical harness clamp (A) and hose clamp (B) (if equipped) with cap screw and retain with lock nut (C).

2.49 Push hydraulic hoses up and through feeder house pivot casting and discard hoses.

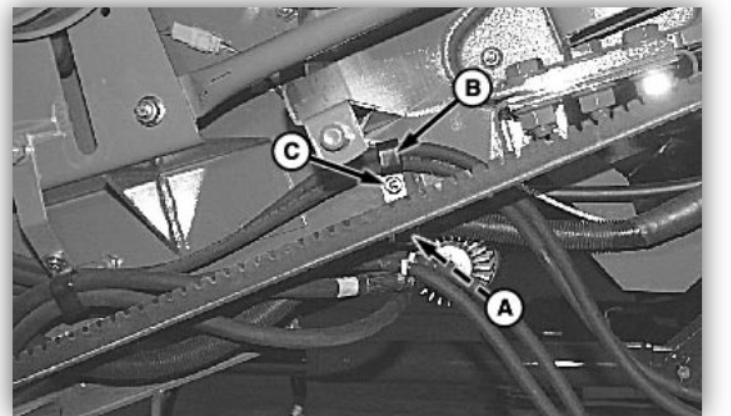

Figure 2.29

Refer to Figure 2.30

2.50 Loosen and remove hydraulic hose (A).

2.51 Remove nut (B) from hydraulic quick coupler (C) and retain.

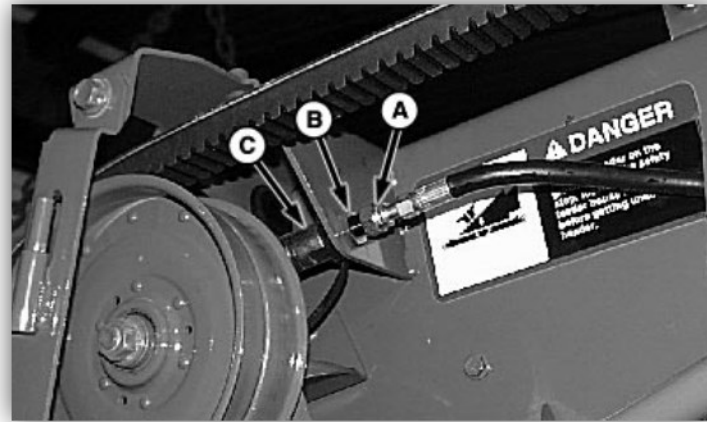

Figure 2.30

Refer to Figure 2.31

2.52 Remove and retain fitting (A) from hydraulic quick coupler (B).

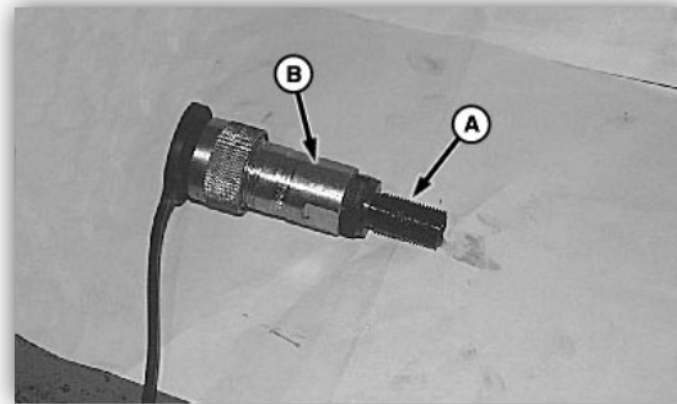

Figure 2.31

Refer to Figure 2.32

2.53 Install upper variable speed hydraulic hose (A) onto upper variable speed extension hose (B) (LANAH208408) and tighten.

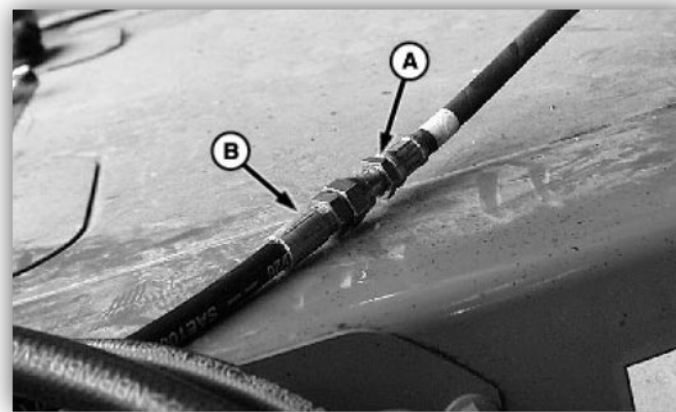

Figure 2.32

Refer to Figure 2.33

2.54 Remove and discard plug (A) from single point hook up (LAN3PLK-0-5BFC).

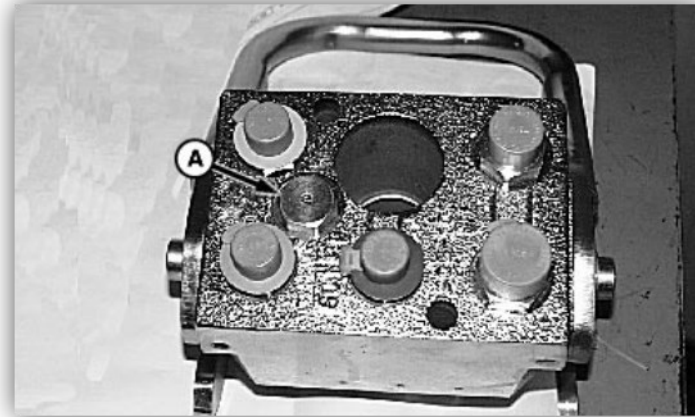

Figure 2.33

Refer to Figure 2.34

NOTE: Make sure O-ring is installed onto hydraulic fitting to prevent hydraulic leaks.

2.55 Install and retain previously removed fitting (A) with O-ring (B) in single point hookup.

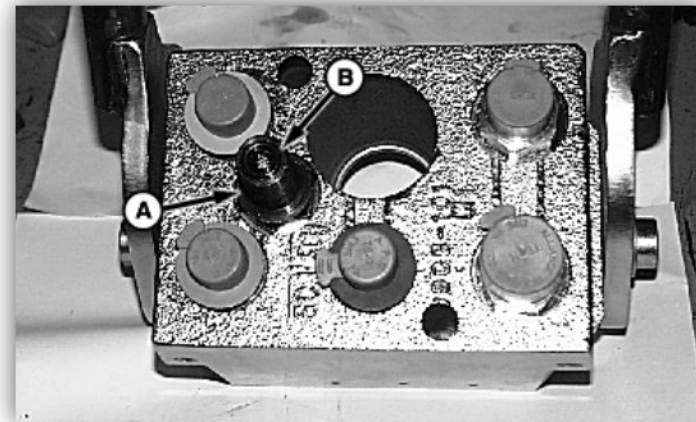

Figure 2.34

Refer to Figure 2.35

NOTE: DO not tighten hoses at this time to allow hoses to swivel and to prevent binding of hoses. If combine is not equipped with reel extend or reel retract, install hydraulic caps to prevent foreign material from entering the hydraulic system.

2.56 Install reel extend hose (light blue) (LANAH206906) (if equipped) (A), priority reel drive hose (B) (LANAH206909) (yellow), reel drive hose (C) (LANAH206913), reel retract hose (dark blue) (LANAH206907)(if equipped) (D), reel life hose (light green) (LANAH206904) (E) and upper variable speed extension hose (LANAH208408) (F).

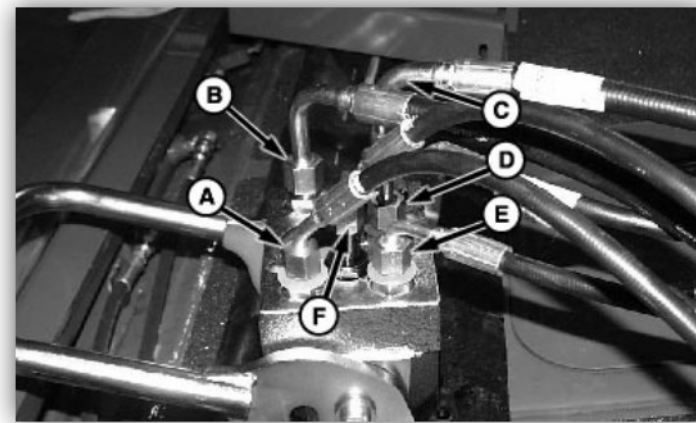

Figure 2.35

Refer to Figure 2.36

NOTE: Leave enough hose so when feeder house is pivoted downward hydraulic hoses will not be damaged.

2.57 Route new reel extend hose (A) (LANAH206906) (light blue ring) (if equipped), reel retract hose (B) (LANAH206907) (dark blue ring) (if equipped) and reel lift hose (C) (LANAH206904) (light green ring) along left-hand side to hydraulic valve stack.

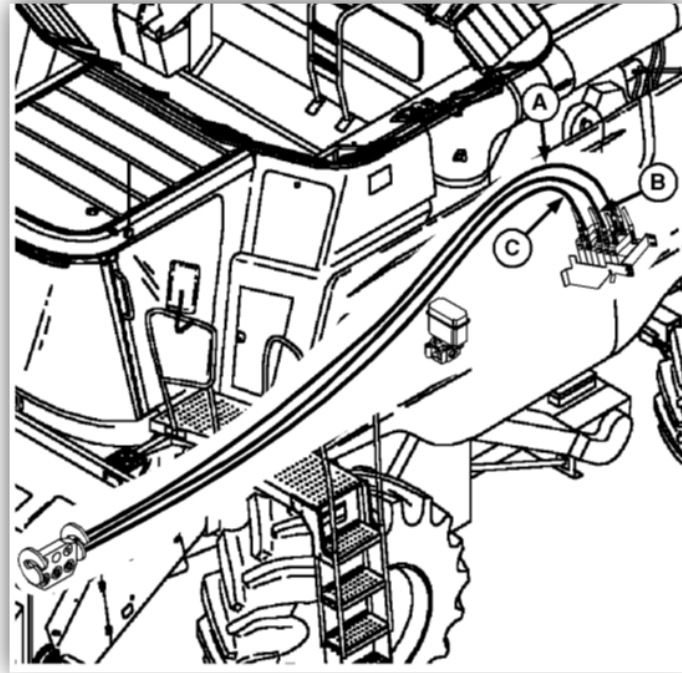

Figure 2.36

Refer to Figure 2.37

2.58 Route reel drive return hose (A) (LAN206894) (red), and reel drive priority hose (B) (LANAH206909) (yellow) along left-hand side to reel speed control valve.

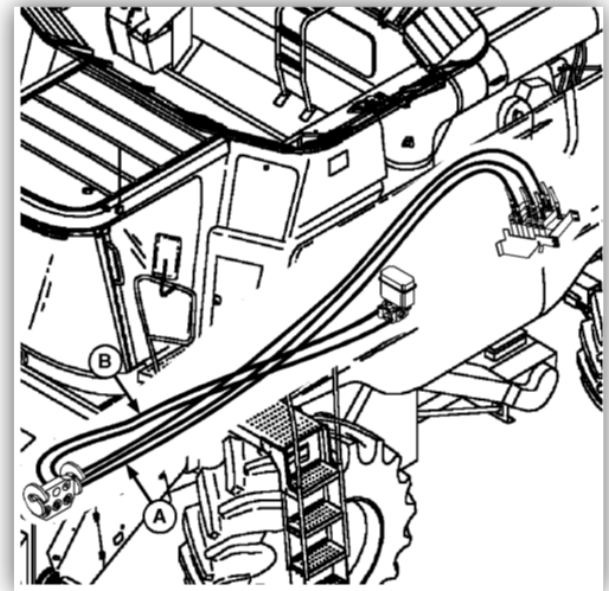

Figure 2.37

Refer to Figure 2.38

2.59 Install and tighten reel extend hose (light blue) (if equipped) (A), reel retract hose (dark blue) (if equipped) (B) and reel lift hose (light green) (C).

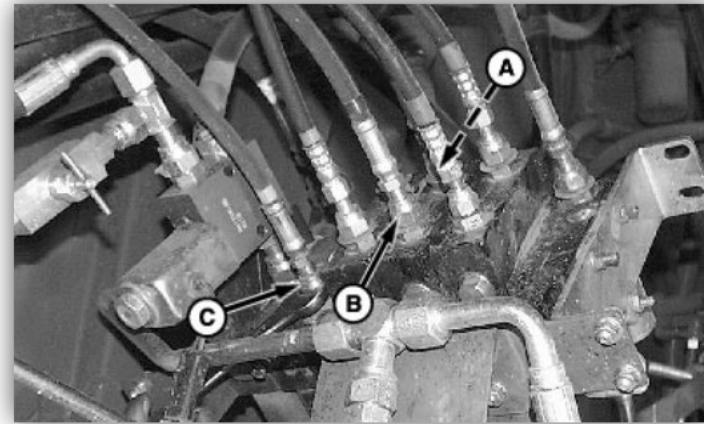

Figure 2.38

Refer to Figure 2.39

NOTE: Position hoses so no binding is found.

If combine is not equipped with reel extend or reel retract, install hydraulic caps (LAN6FF) to prevent foreign material from entering the hydraulic system.

2.60 Position single point hookup (LAN3PLK-0-5BFC) as it would be when installed and tighten reel extend hose (light blue) (if equipped) (A), priority reel drive hose (B), reel drive return hose (C), reel retract hose (dark blue) (if equipped) (D), reel lift hose (light green) (E), and upper variable speed feeder house hose (F).

Refer to Figure 2.40

2.61 Install single point hookup and retain with four cap screws (LAN19M7865) (A).

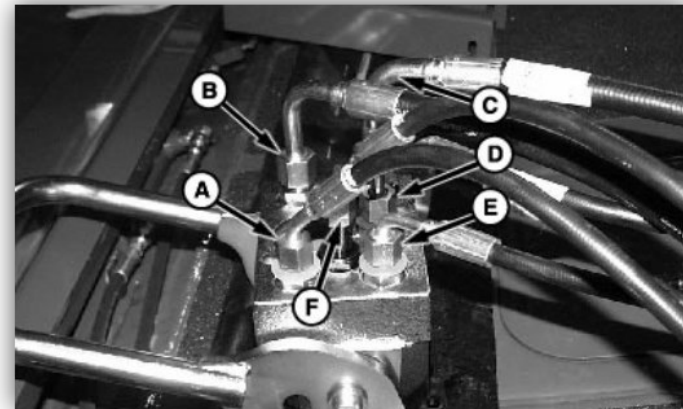

Figure 2.39

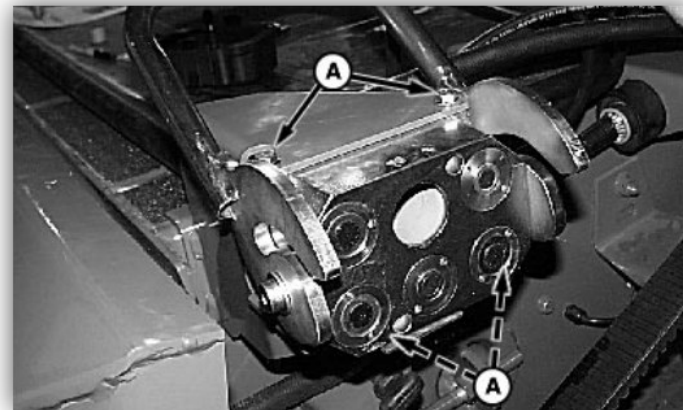

Figure 2.40

Refer to Figure 2.41

2.62 Install and tighten reel drive priority hose (A) and reel drive return hose (B) on reel speed flow control valve.

2.63 Remove vacuum pump from hydraulic reservoir. Add hydraulic oil if reservoir had to be drained.

Refer to Figure 2.42

Note: Leave enough hydraulic hose to prevent damage to hoses when feeder house is fully lowered.

Retain hydraulic hoses with tie straps as necessary to prevent hoses from coming in contact with belts.

2.64 Install and retain hose clamp (C), bracket (B), and hardware (A).

2.65 Install and retain hose clamp (E) and hardware (D).

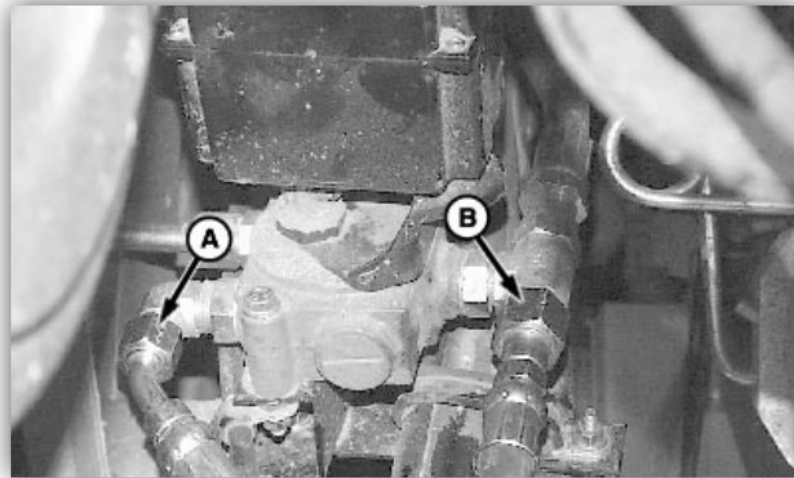

Figure 2.41

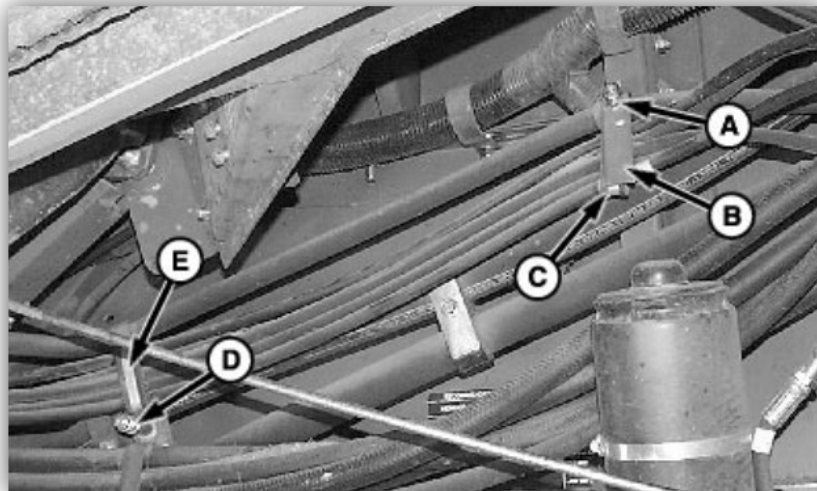

Figure 2.42

Refer to Figures 2.43 & 2.44

NOTE: Retain hydraulic hoses with tie straps as necessary to prevent hoses from coming in contact with belts.

2.66 Install and tighten cap screws and lock nuts (A).

2.67 Install and tighten hose clamps (B) around hydraulic hoses.

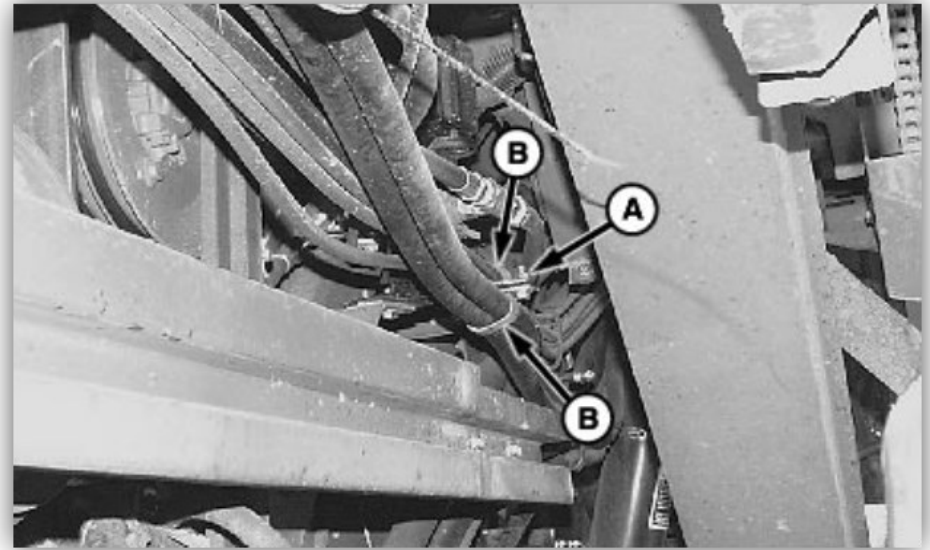

Figure 2.43

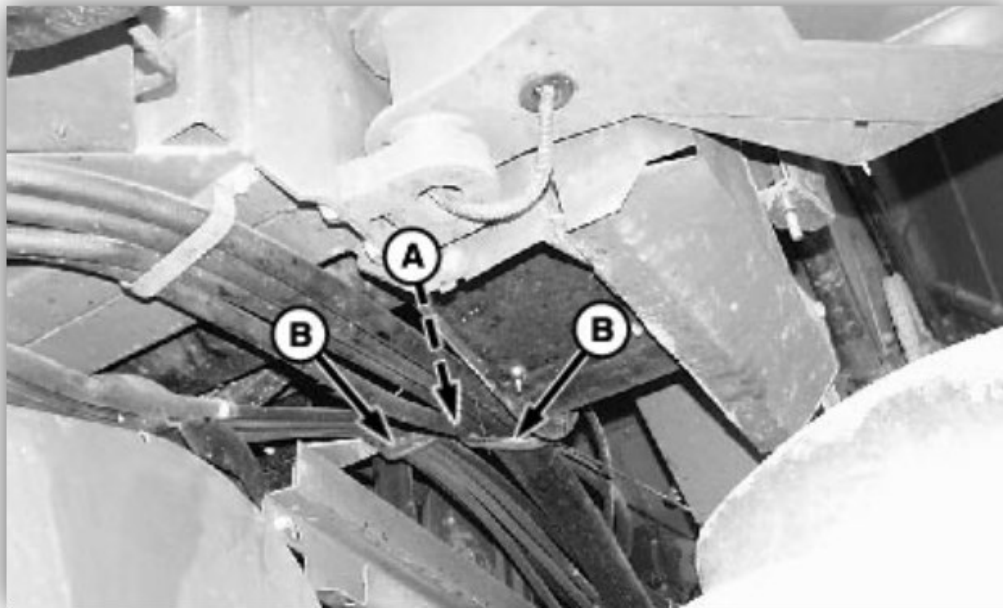

Figure 2.44

Refer to Figure 2.45

2.68 Install and retain reel drive priority hose and reel drive return hose using tie straps (REDVTG5) (A); keep hoses away from variable speed feeder house belt (B).

Refer to Figure 2.46

2.69 Install hose clamp (A) and retain with cap screw (B).

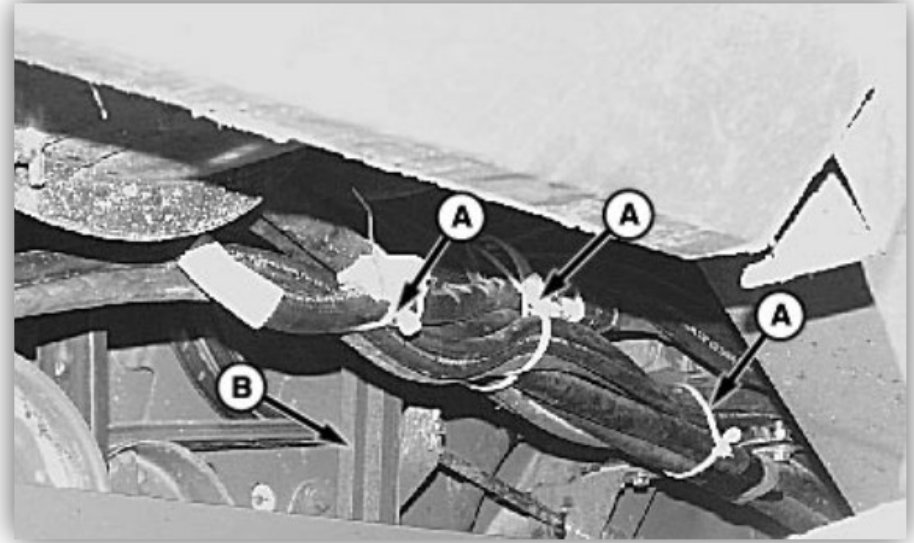

Figure 2.45

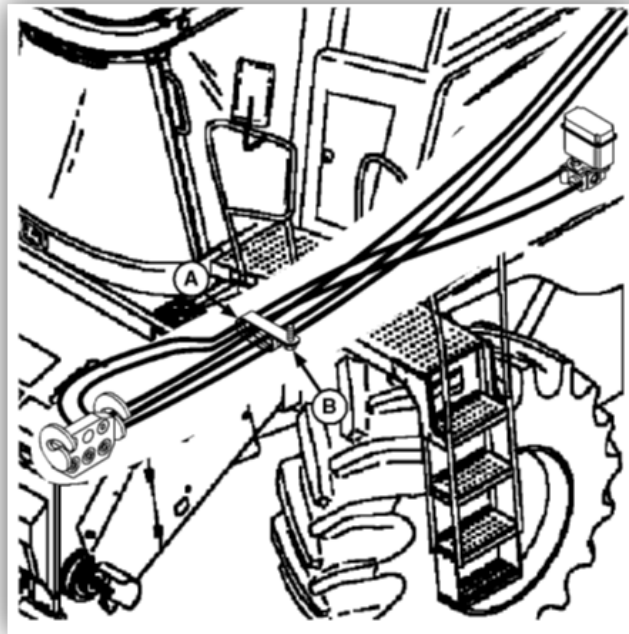

Figure 2.46

Refer to Figure 2.47

2.70 Install two rubber seals (A) (LANH202240) onto dust cap (B) (LANH201368).

Refer to Figure 2.48

2.69 Install dust cap (A) (LANH201368) onto single point hookup.

Refer to Figure 2.49

2.70 Install hose shield (A) (LANH204885) over hydraulic hoses. Retain with M8 lock nuts (LAN14M7298) (B) and M8 x 15 self tapping screw (LAN19M7865) (C).

IMPORTANT: Surface of shield must be clean and dry before installing skid resistant mat.

2.71. Install skid resistant mat (D) (RED-TRC-TAPE) onto shield.



Figure 2.47

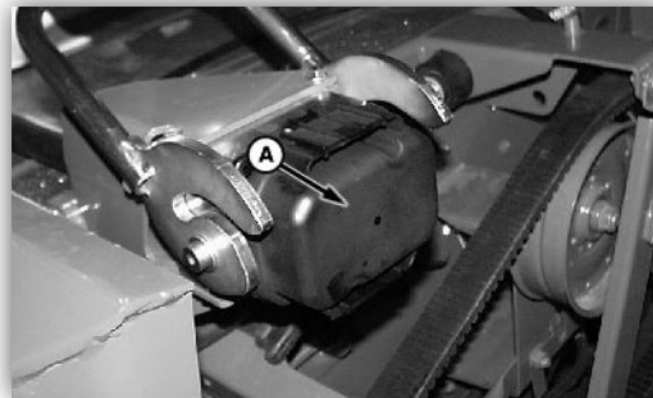

Figure 2.48

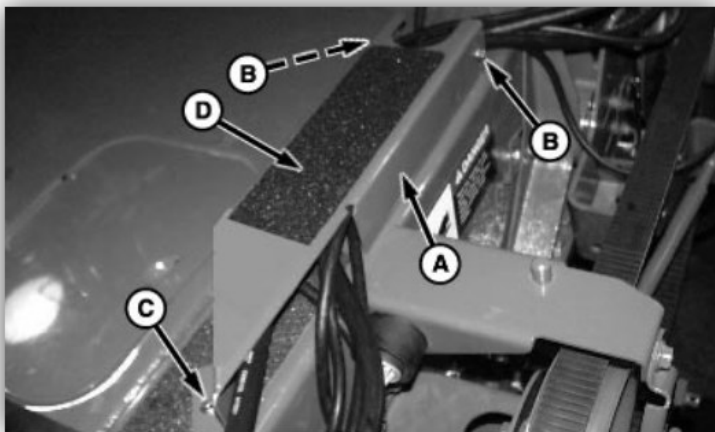

Figure 2.49

Refer to Figure 2.50

2.72 Install and retain shield (B) with cap screws (A).

Refer to Figure 2.51

2.73 Install and retain shield (B) with quick-lock pin (A).

Refer to Figure 2.52

2.73 Install shield (C) and retain with quick-lock pins (B).

2.74 Tighten cap screw.

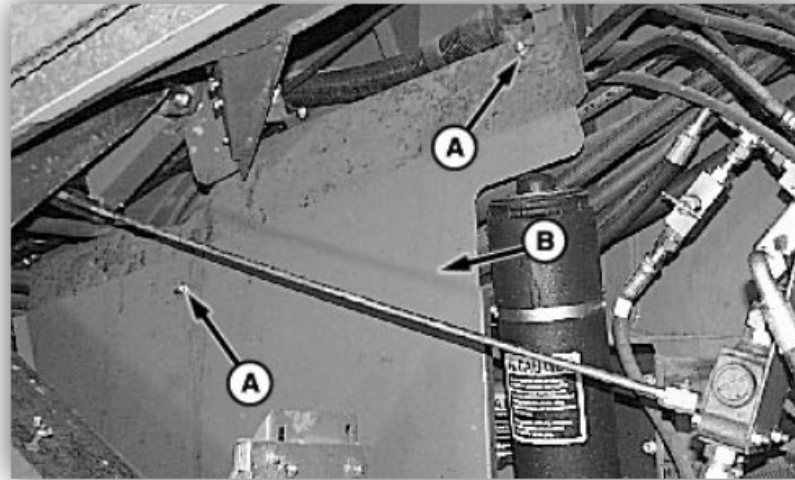

Figure 2.50

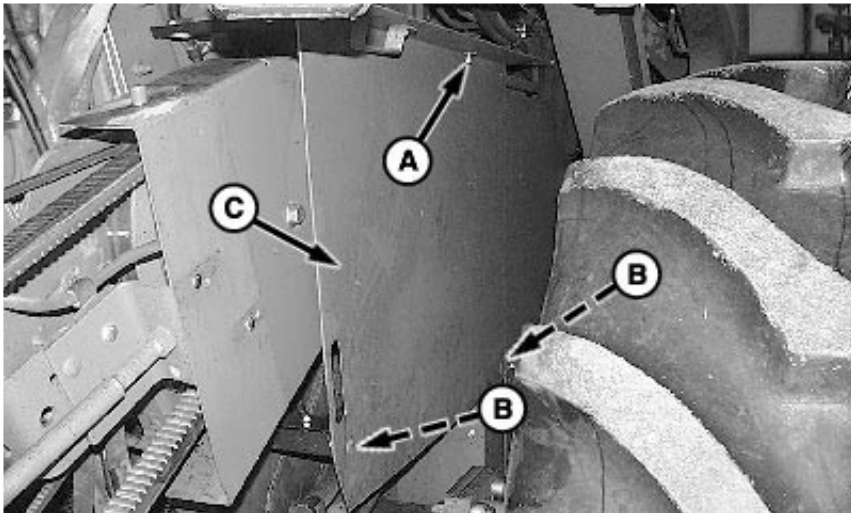

Figure 2.52

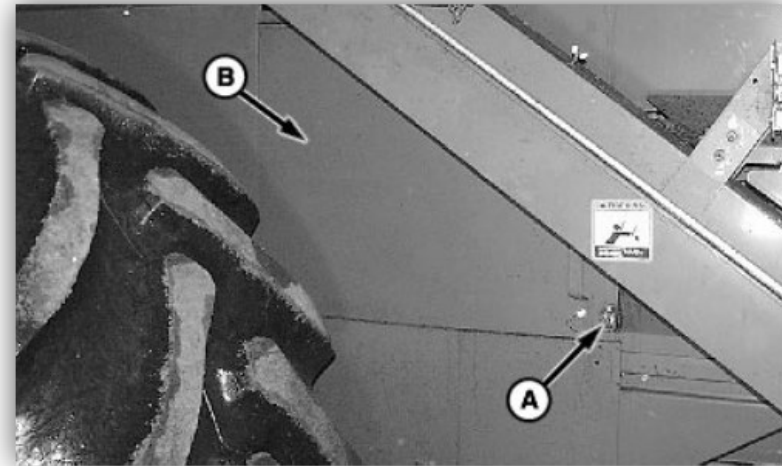

Figure 2.51

Refer to Figure 2.53

- 2.75 SIDEHILL COMBINES ONLY: Measure a distance (A) of 175 mm (6 - 7/8") and scribe a line.
- 2.76 SIDEHILL COMBINES ONLY: Measure a distance (B) of 50 mm (2") from previous scribed line and scribe a line.
- 2.78 SIDEHILL COMBINES ONLY: Measure a distance (C) of 50 mm (2") and scribe a line.
- 2.79 SIDEHILL COMBINES ONLY: Remove material from scribed line area and smooth edges.

Refer to Figure 2.54

- 2.80 Install rear shield and retain with quick-lock pin (A).
- 2.81 Install left-hand feeder house shield with rubber strap (B) and retain with cap screw (C).
- 2.82 Start engine and check for hydraulic leaks.

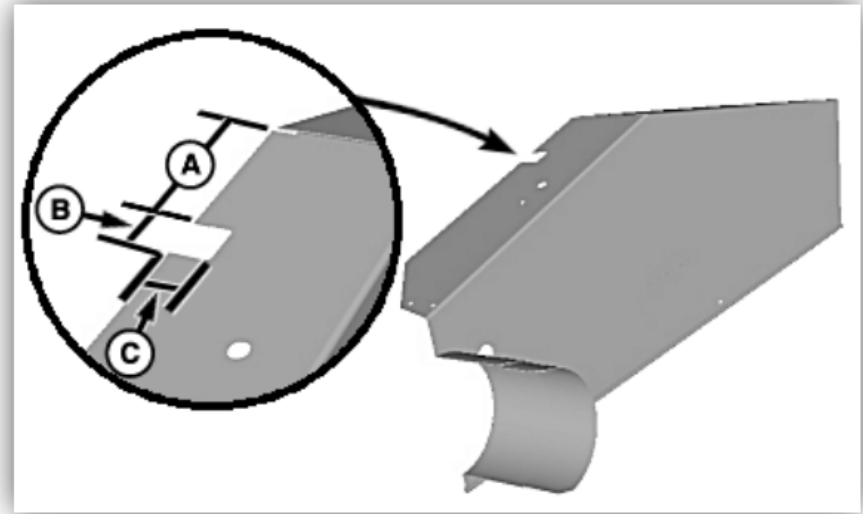

Figure 2.53

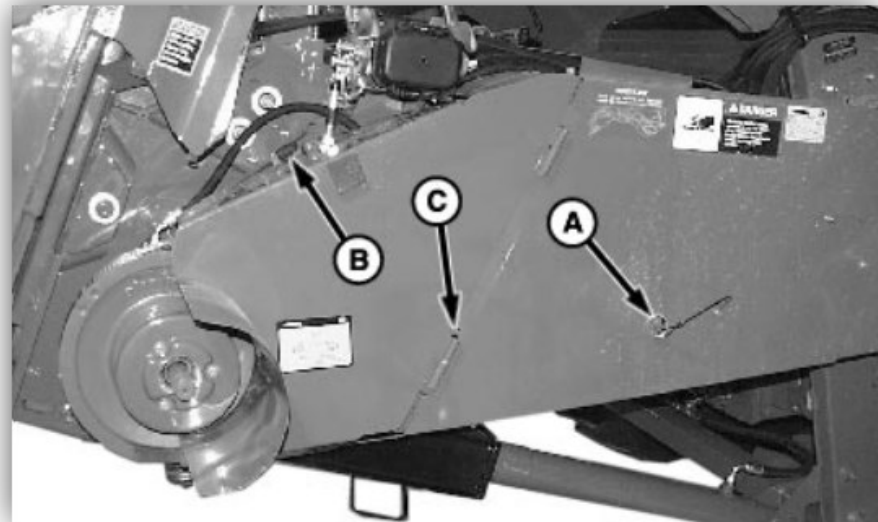

Figure 2.54

Refer to Figure 2.55

NOTE: When lowering feeder house to ground, make sure hydraulic hoses are long enough to prevent damage to hoses.

2.83 Raise feeder house to remove jack stands (A) and fully lower feeder house.

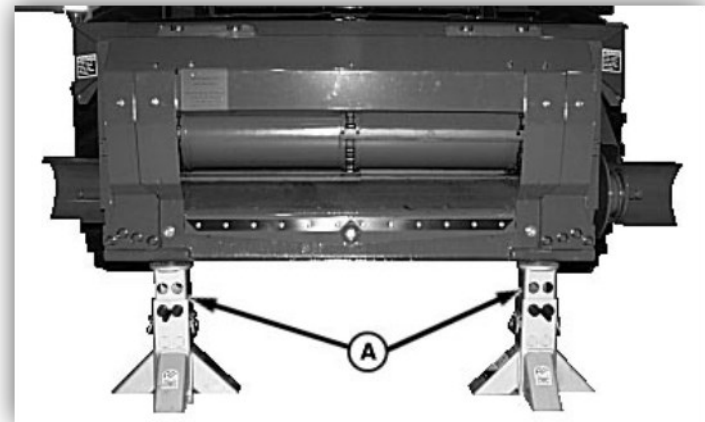

Figure 2.55

3. Install Conversion Feeder House Wiring Harness

Refer to Figure 3.1

3.1 Remove main wiring harness (A) from storage position (B).



Figure 3.1

Refer to Figure 3.2

3.2 Attach main wiring harness connector (A) to adapter harness (LAN209735).

Refer to Figure 3.3

3.3 Install electrical harness (A) through single point hookup and align harness with notch (B).

3.4. Retain electrical harness with snap ring (C) (LANH175881).

**For further technical assistance,
contact Lankota at
1 - 866 - 526 - 5682**

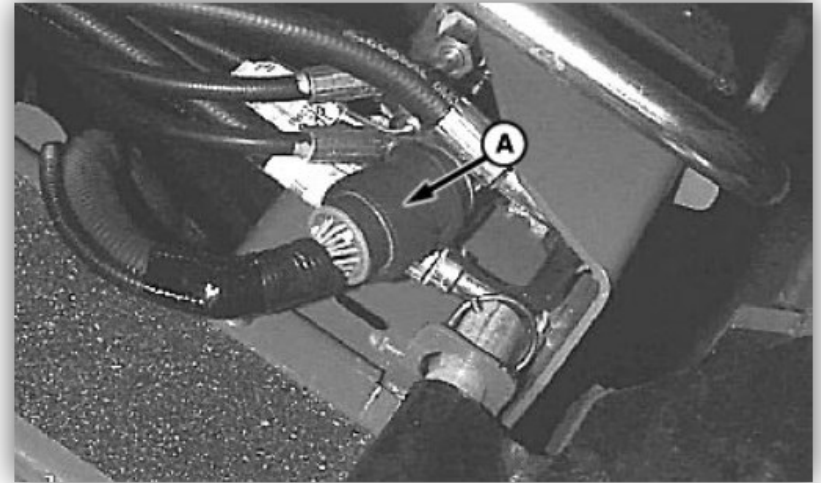

Figure 3.2

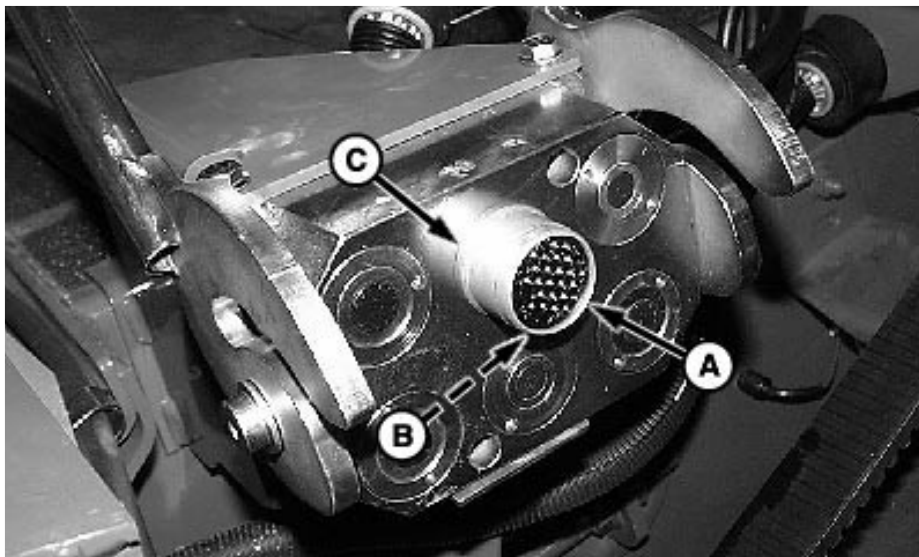

Figure 3.3