

LANFLAG22483

Installation Instructions

Lankota Flag Pole Universal Mount Kit for MoCo's with Round Rod Lifting Eye on Boom







LANKOTA®

**270 West Park Avenue
Huron, SD 57350
866-526-5682**

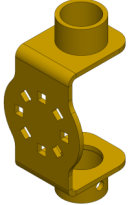
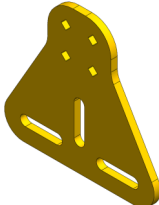
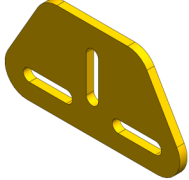
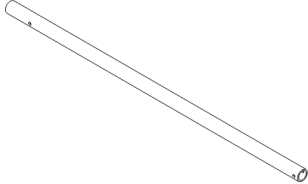
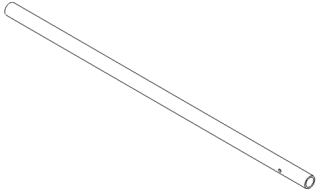
Parts

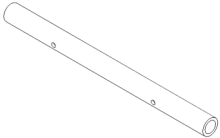
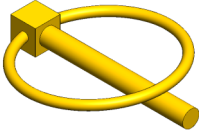
Part Number	Description	Qty
LAN2138201	Flag Pole Holding Mount	1
LANFLAG101	Mounting Bracket	1
LANFLAG102	Mounting Bracket Backer Plate	1
LANFLAG03D-01	Flag Pole—Drilled—2.5' Bottom Piece	1
LANFLAG03D-02	Flag Pole—Drilled—2.5' Top Piece	1
LANFLAG04	Flag Pole Rotating Rings (Pair)	1
LANFLAG07	Flag Pole Connection Tube	1
LAN1101	3/16" x 1 1/2" Lynch Pin	1
LAN97526A140	3/16" Domed Rivet—For 1/4" Material	4
LANF103K	1/4" x 3/4" Carriage Bolt	4
LANEJRN	1/4" Flanged Nyloc Nut	4
LAN18A32	3/8" x 1 1/2" Carriage Bolt	3
LAN3718	3/8" Serrated Flange Nut	3

Parts

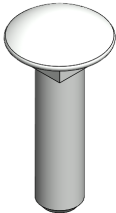
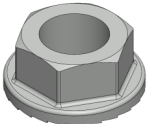
 <p>LAN2138201 (1)</p>	 <p>LANFLAG101 (1)</p>	 <p>LANFLAG102 (1)</p>	 <p>LANFLAG03D-01 (1)</p>
 <p>LANFLAG03D-02 (1)</p>	 <p>LANFLAG04 (1 PAIR)</p>	 <p>LANFLAG07 (1)</p>	 <p>LAN1011 (1)</p>
 <p>LAN97526A140 (4)</p>	 <p>LANF103K (4)</p>	 <p>LANEJRN (4)</p>	 <p>LAN18A32 (3)</p>
 <p>LAN3718 (3)</p>			

Installation

NOTE: One portion of the flag pole has two sets of holes - this one is the BOTTOM (LANFLAG03D-01).

Refer to Figures A & B

1. Place the flag pole connection tube (LANFLAG07) inside the bottom flag pole section (LANFLAG03D-01) and attach with two rivets (LAN97526A140) using the holes that are 2.5" in from one end of the flag pole section.
2. Slide the top flag pole section (LANFLAG03D-02) over the connection tube and attach with two rivets.

Figure A

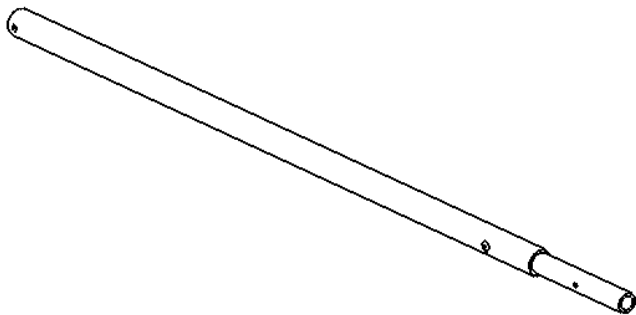
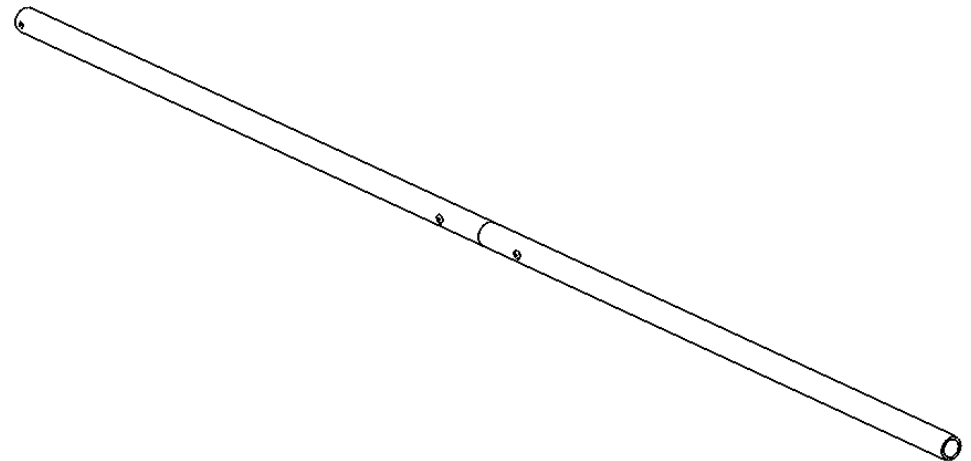

Figure B



Installation

NOTE: There is a hole drilled through one end of the flag pole. This end is the **BOTTOM**.

Refer to Figures 1 & 2

1. Measure the height of your flag. Then install one flag rotating ring onto the flagpole that distance from the top with the rotating ring **TOWARD THE TOP**.
2. Tighten the large set screw to hold the flag mount in place.
3. Loosen the small set screw and unscrew the retaining ring until it lines up with the large set screw. This will provide enough clearance for the rings to properly rotate. Tighten the small set screw.



Figure 1



Figure 2

Installation

NOTE: There is a hole drilled through one end of the flag pole. This end is the **BOTTOM**.

Refer to Figures 3 & 4

4. Next, install one flag rotating ring onto the top of the flagpole with the rotating ring **TOWARD THE BOTTOM**.
5. Tighten the large set screw to hold the flag mount in place.
6. Loosen the small set screw and unscrew the retaining ring until it lines up with the large set screw. This will provide enough clearance for the rings to properly rotate. Tighten the small set screw.
7. Attach the carabiners to the rotating rings.



Figure 3



Figure 4

Installation

Refer to Figure 5

8. Bolt the flag pole holding mount (LAN2138201) to the mounting bracket (LANFLAG101) with four 1/4" x 3/4" carriage bolts (LANF103K) and four 1/4" nyloc flange nuts (LANEJRN).

Refer to Figure 6

9. Locate the desired lifting eye on the boom and use the mounting bracket (LANFLAG101) and the backer plate (LANFLAG102) to clamp around the lifting eye using three 3/8" x 1/2" carriage bolts (LAN18A32) and 3/8" serrated flange nuts (LAN3718). If possible keep the three bolts inside the lifting eye.

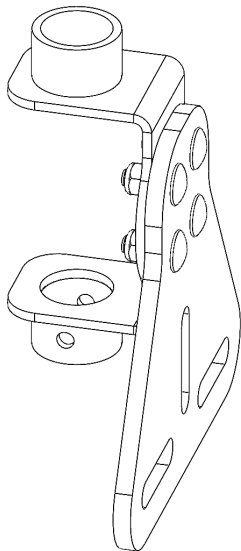

Figure 5



Figure 6

Refer to Figure 7

10. Slip the flag pole into the mount. Retain with the included lynch pin (LAN1101).

Figure 7



For further technical assistance, call Lankota Inc. at:

1-866-526-5682